

TURBOSAND

STANDARD PATTERNS

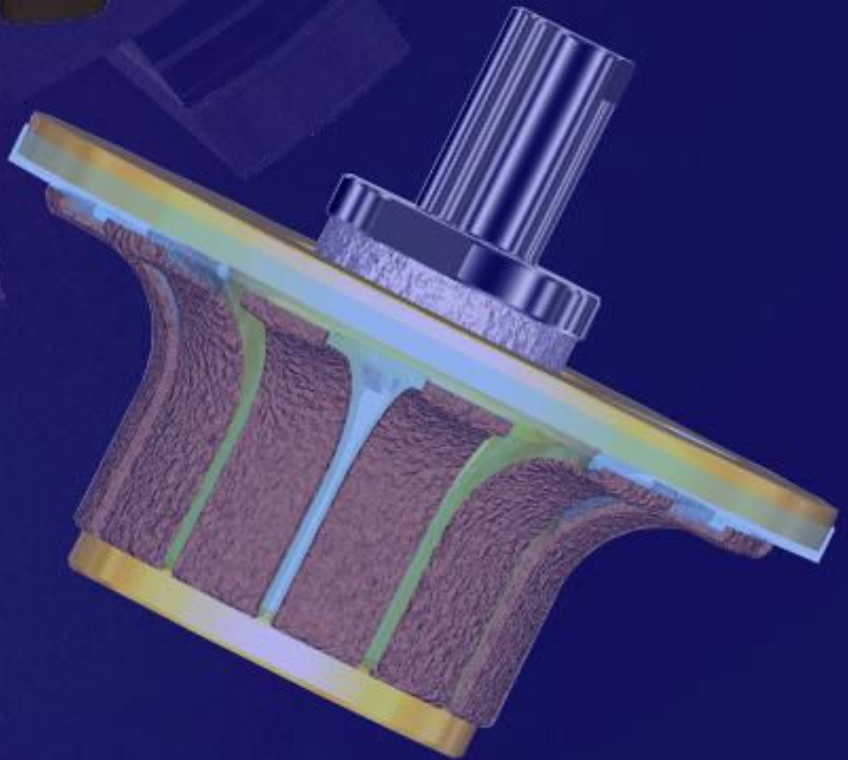

TURBOSAND ABRASIVE PRODUCTS

2350 BARNEY STREET, ANDERSON CA 96007

Phone: 1-877-348-8726 Fax: 1-530-365-1007

<http://www.turbosand.com>

Contents

SQUARE EDGE	3
BEVEL EDGE.....	3
DUAL SYMMETRIC	3
DUAL ASYMMETRIC.....	4
FACE DOWN.....	4
FACE-UP.....	5
BULLNOSE.....	7
TRUE RADIUS.....	7
ELLIPTICAL	8
¼ ROUND.....	8
½ ROUND.....	8
CORNER ROUND	9
SYMMETRIC DUAL RADIUS	9
ASYMMETRIC DUAL RADIUS	11
RADIUS FACE-UP.....	11
RADIUS FACE-DOWN	14
COVE EDGE.....	16
FACE-UP.....	16
FACE-DOWN	17
DUAL	17
DOOR/DRAWER PULL.....	18
CORNER-ROUND WITH BEVEL PULL	18
BEVEL TOP WITH BEVEL PULL.....	18
2-CURVE WITH BEVEL PULL	19
3-CURVE WITH BEVEL PULL	22
4-CURVE WITH BEVEL PULL	23
5-CURVE WITH BEVEL PULL	24
6-CURVE WITH BEVEL PULL	25
7-CURVE WITH BEVEL PULL	25
BEVEL TOP WITH CONCAVE PULL.....	25
SQUARE EDGE WITH CONCAVE PULL.....	25
CORNER ROUND WITH CONCAVE PULL.....	26
2-CURVE WITH CONCAVE PULL	26
3-CURVE WITH CONCAVE PULL	28
4-CURVE WITH CONCAVE PULL	29
5-CURVE WITH CONCAVE PULL	29
CORNER ROUND WITH CONVEX PULL.....	29
2-CURVE WITH CONVEX PULL	30
3-CURVE WITH CONVEX PULL	31
4-CURVE WITH CONVEX PULL	32
5-CURVE WIT CONVEX PULL	32
6-CURVE WIT CONVEX PULL	32
OGEE EDGES	33
2-CURVE PROFILE.....	33
PLOUGH CUT.....	42

RAISED PANEL.....	44
SIMPLE BEVEL	44
SIMPLE SCOOP	45
BEZEL / SIMPLE LIP.....	50
BEZEL / 2-CURVE.....	54
BEZEL / 3-CURVE.....	55
BEZEL / 4-CURVE.....	56
BEZEL / 5-CURVE.....	56
WATERFALL / 2-CURVE	57
WATERFALL / 3-CURVE	57
WATERFALL / 4-CURVE	63
WATERFALL / 5-CURVE	64
WATERFALL / 7-CURVE	67
SOFT EDGE.....	68
EDGE BEAD & RAILS	68
WATERFALL EDGE.....	70
3-CURVE ROLLING.....	70
3-CURVE 2-BEAD.....	70
3-CURVE S-BEAD.....	70
4-CURVE ROLLING.....	71
4-CURVE ROMAN BEAD.....	75
4-CURVE / CORINTHIAN	76
4-CURVE / 2-BEAD LIP.....	78
4-CURVE / 3-STEP	78
5-CURVES	78
6-CURVES	79
7 & 8 CURVES	80
BACKCUT.....	81
COPE PROFILES.....	82
BEVELED EDGE.....	82
CORNER ROUND WITH RABBETT.....	83
2-CURVE (OGEE).....	83
SQUARE EDGE (SHAKER)	84
WATERFALLS	84
BEVELED EDGE.....	85
CORNER ROUNDS.....	86
OGEE.....	86
SQUARE EDGE (SHAKER)	88
WATERFALL STYLE.....	89
COMPOUND PROFILES.....	90
REQUIRING 2 SEPARATE INSERTS.....	90



SQUARE EDGE

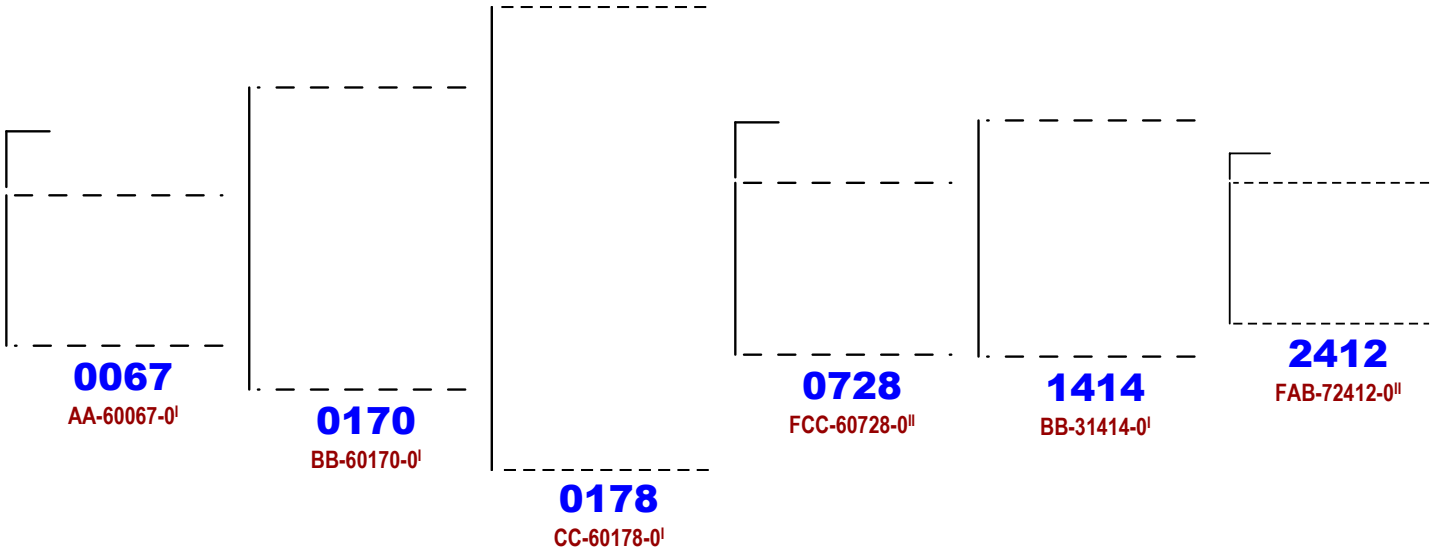

CRDown

BEVEL EDGE

Dual Symmetric

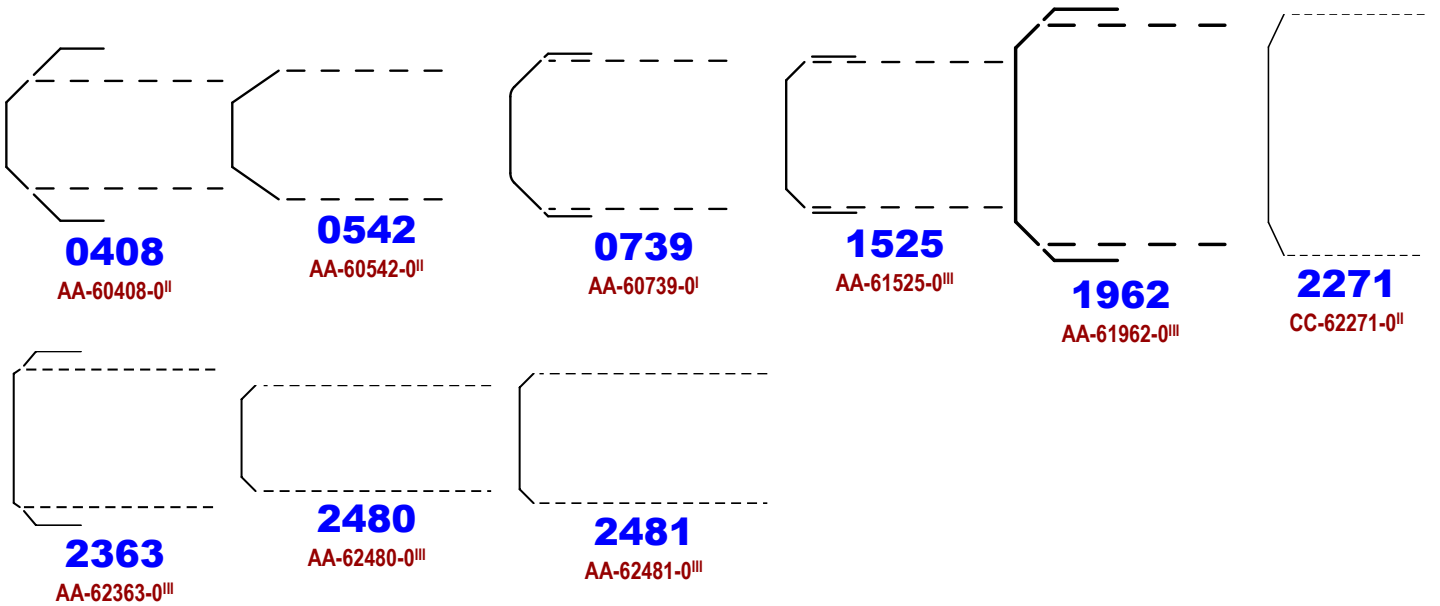

BEVEL EDGE

Dual Asymmetric

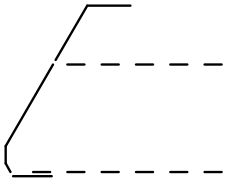

0057
AA-60057-15^{II}

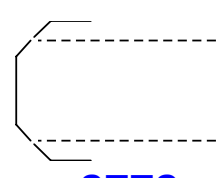

0770
AA-60770-0^{II}

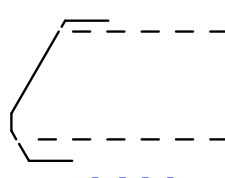

1411
AA-51411-0^{III}

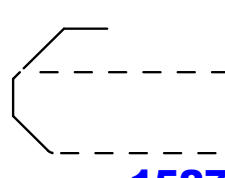

1527
AA-31527-0^{III}

BEVEL EDGE

Face Down

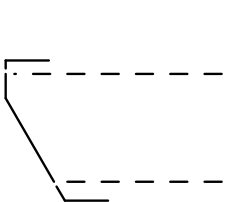

0438
AA-60438-0^{II}

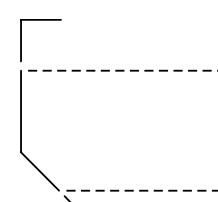

0729
FCC-60729-0^{II}

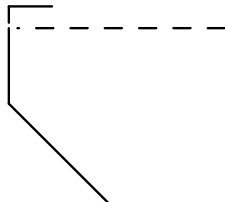

0794
FCC-60794-0^{II}

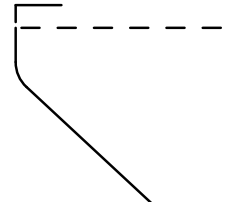

1846
FCC-61846-0^{II}



1874
AA-51874-0^{II}

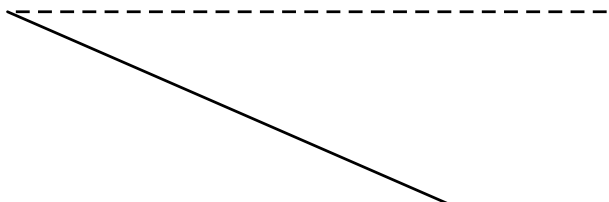
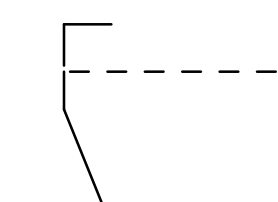

1844
FRP-61844-0^{II}

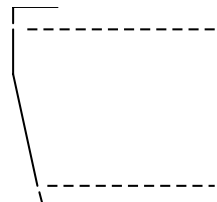

2402
AA-62402-0^{II}

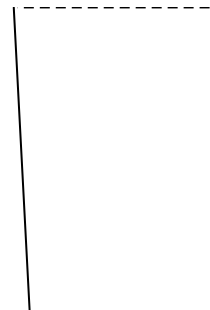

2339
CC-62339-0

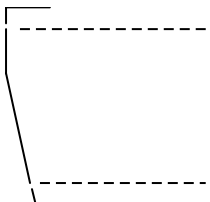

2402
AA-62402-0^{II}

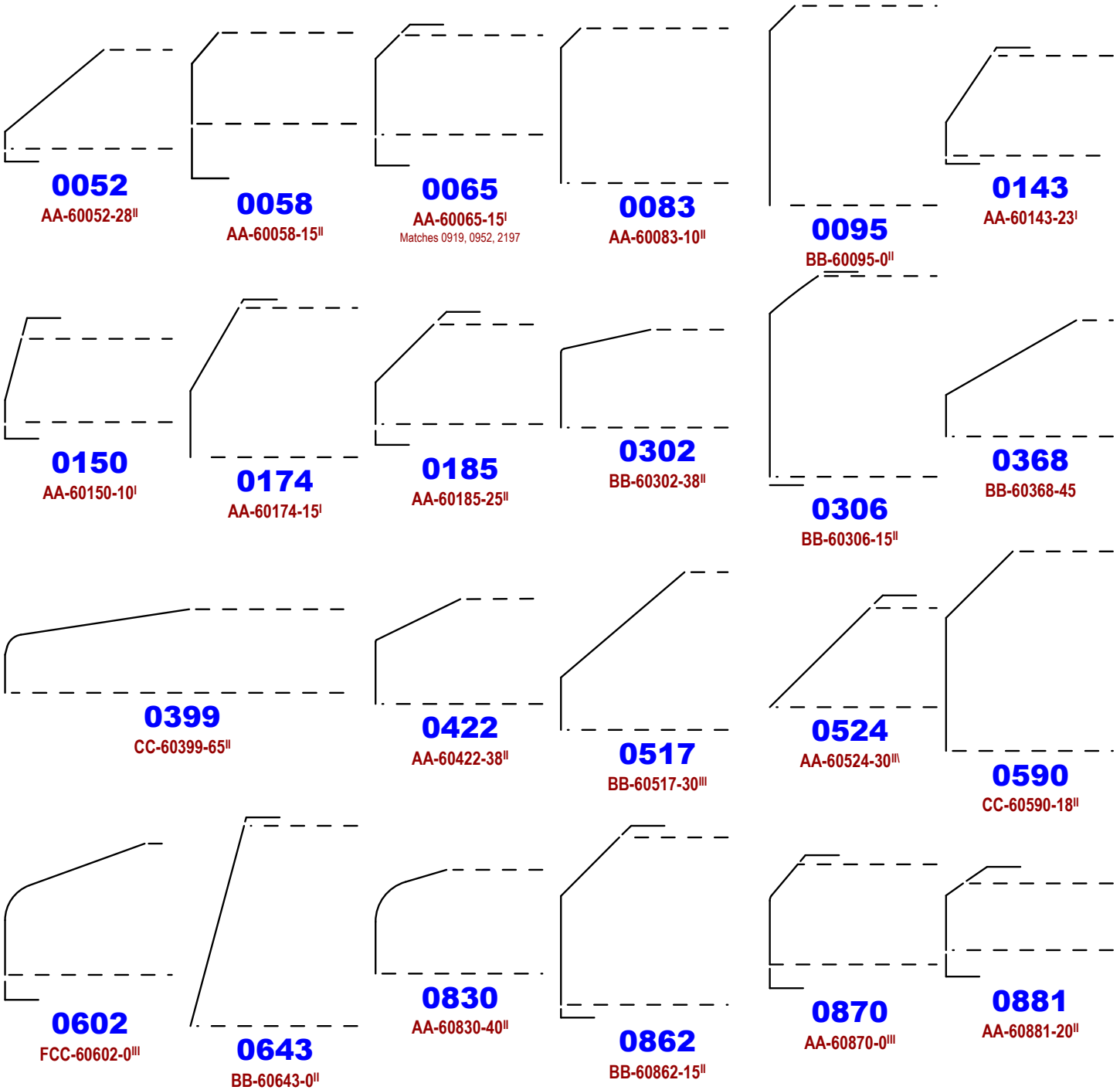

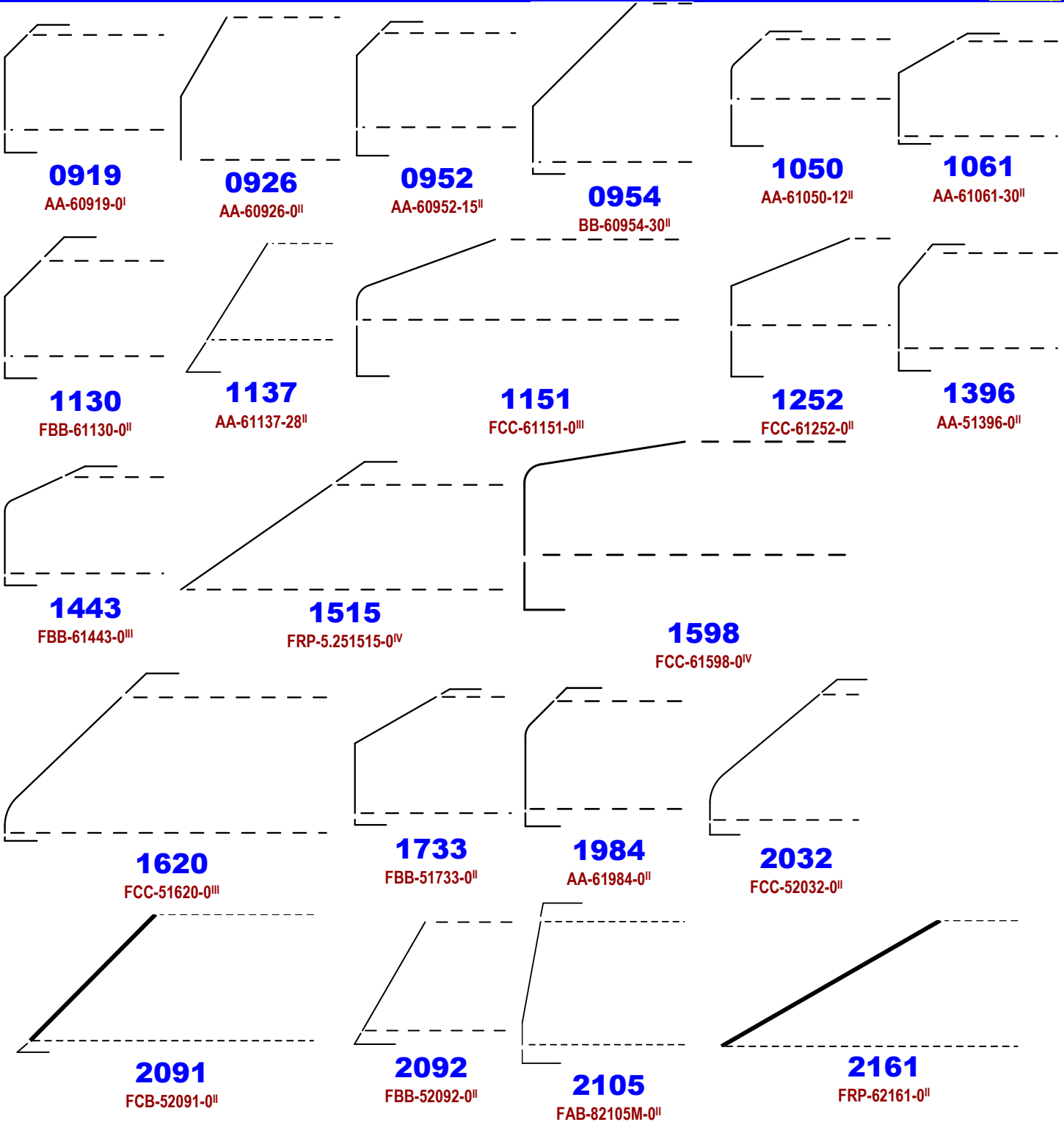

BEVEL EDGE

Face-up

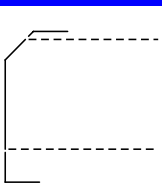

2197

AA-62197-0^{III}

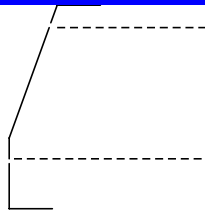

2546

AA-62546-0^{II}

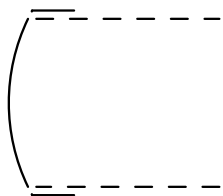

0086

AA-60086-0^I



0199

AA-60199-0^{III}

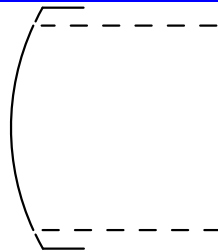

0253

BB-60253-0^{II}

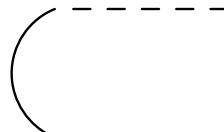

0340

AA-60340-0^{II}

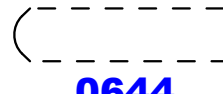

0644

AA-60644-0^{II}

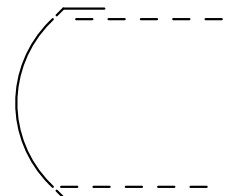

0712

BB-60712-0^{II}

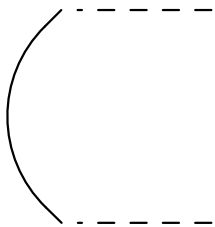

0858

BB-60858-0^{II}

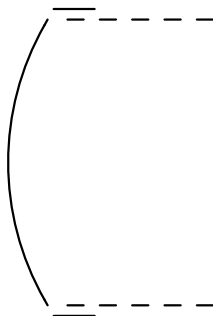

1097

CC-61097-0^{II}



1197

AA-31197-0^{II}

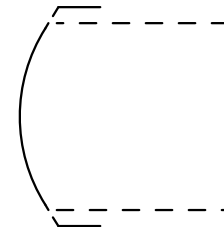

1394

BB-31394-0^{III}

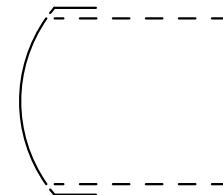

1618

AA-61618-0^{II}

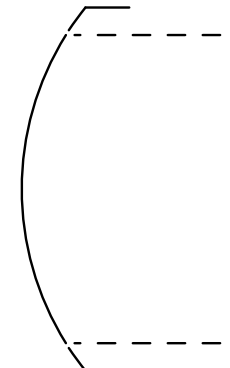

1748

CC-61748-0^{II}

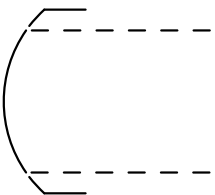

1798

BB-61798-0^{II}



2319

AA-62319-0^{II}

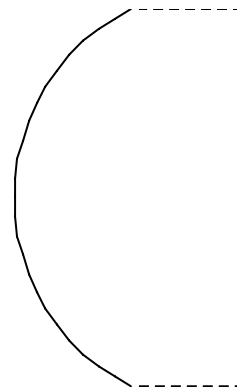

2356

FTB-52356-0^{IV}

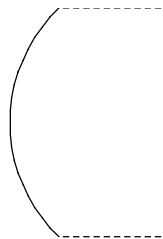

2523

CC-62523-0^{II}

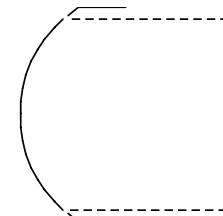

2580

62580-0^{II}

BULLNOSE
Elliptical

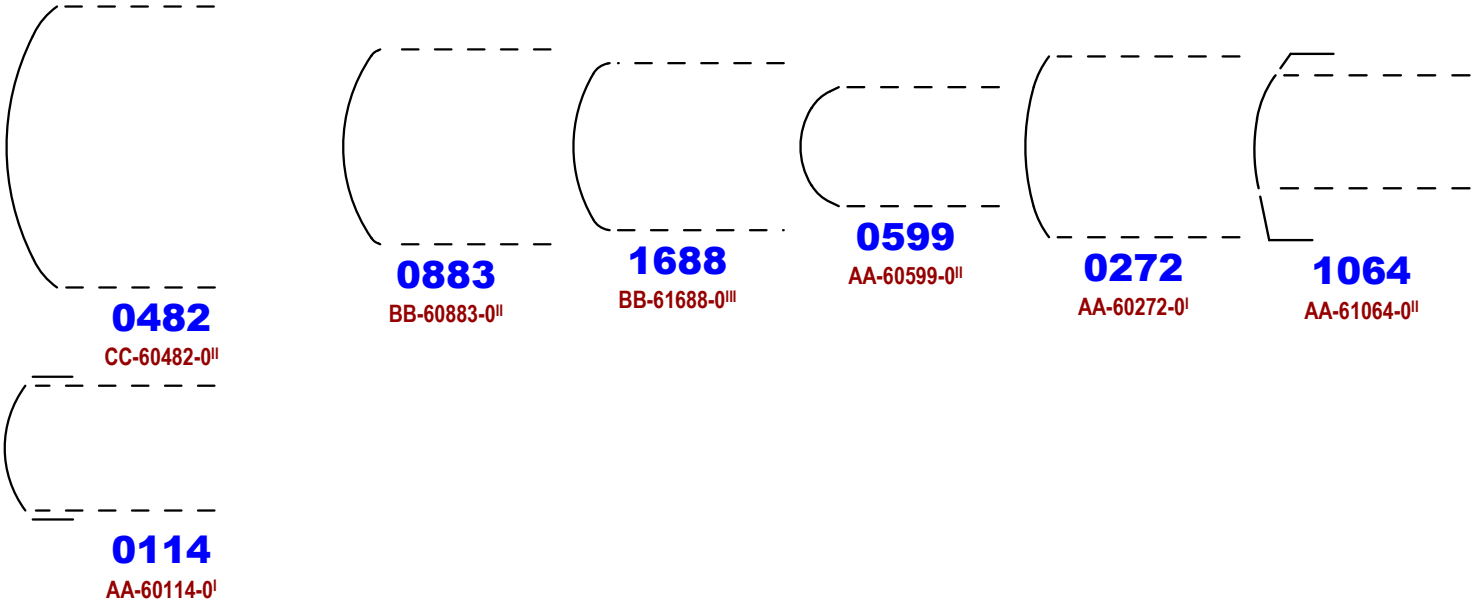

1/4 ROUND

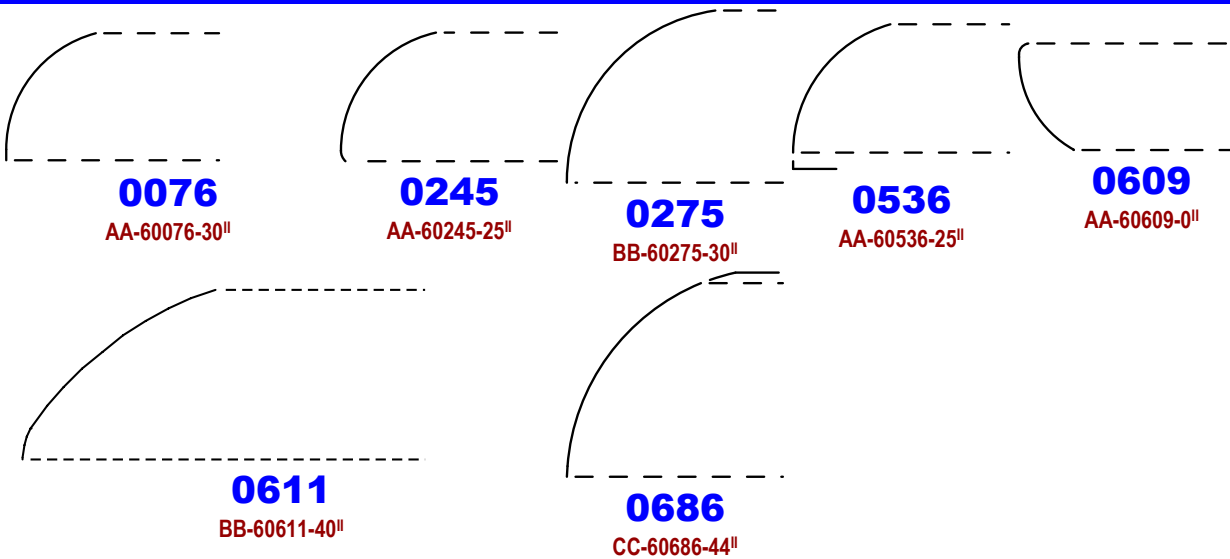

1/2 ROUND

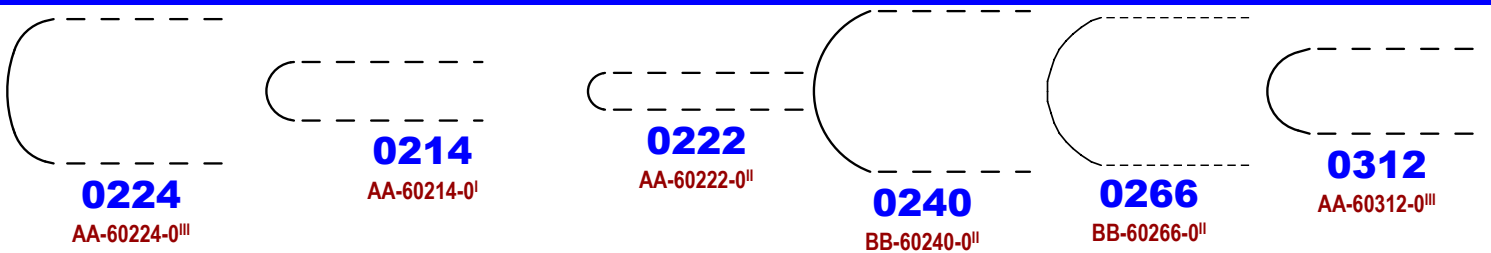

1/2 ROUND

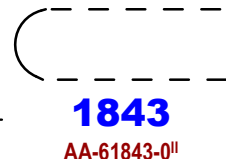
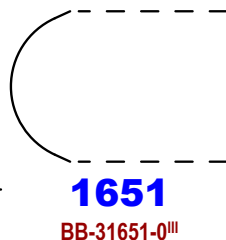
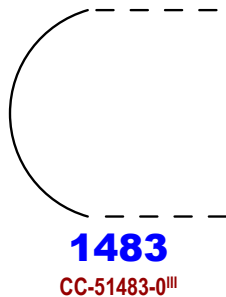
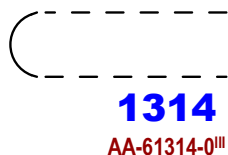
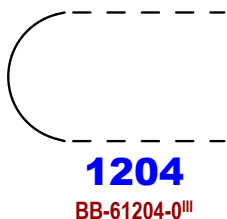
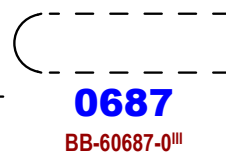
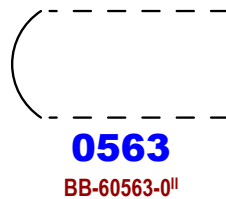
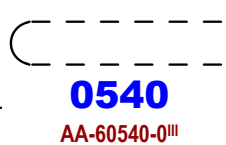
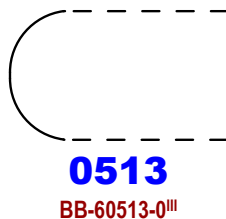
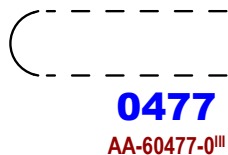
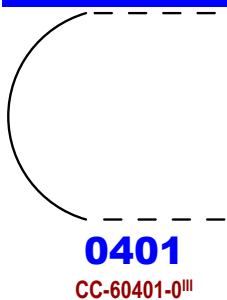

CORNER ROUND

Symmetric Dual Radius

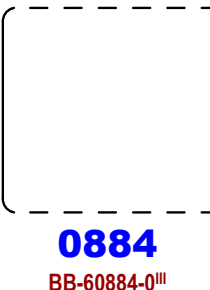
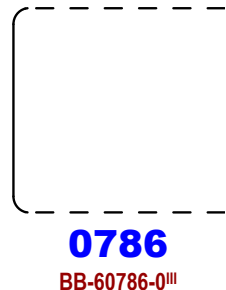
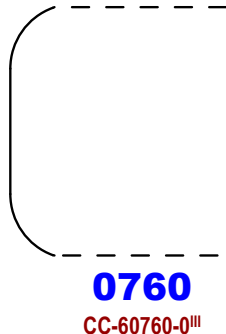
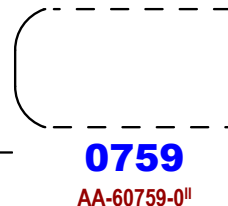
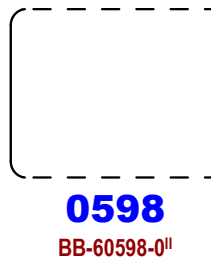
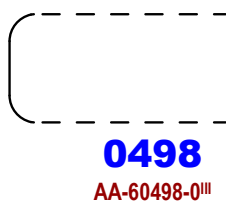
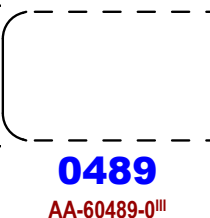
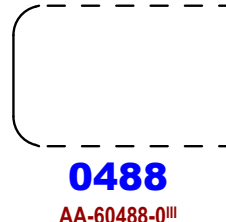
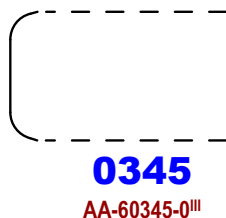
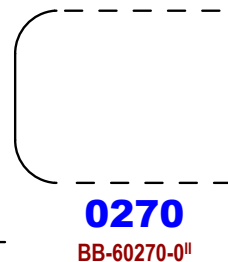
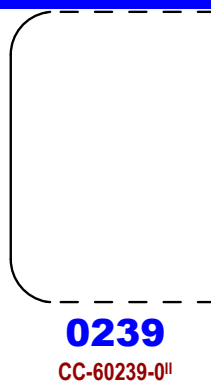
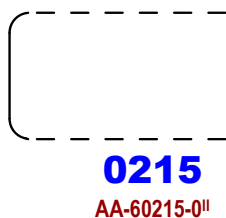

CORNER ROUND

Symmetric Dual Radius

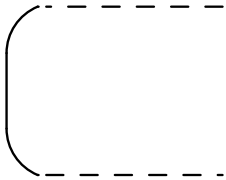

0904

BB-60904-0^{III}

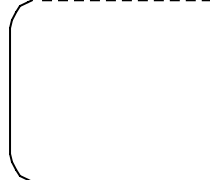

1072

AA-61072-08^{II}

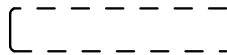

1306

AA-61306-0^{III}



1307

AA-61307-0^{III}



1318

AA-61318-0^{III}

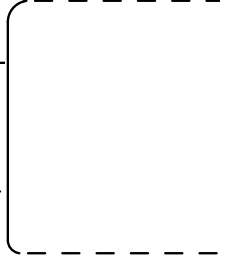

1344

CC-61344-0^{III}

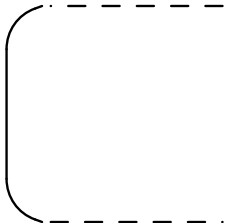

1461

BB-61461-0^{III}



1650

BB-31650-0^{III}



1746

AA-61746-0^{III}

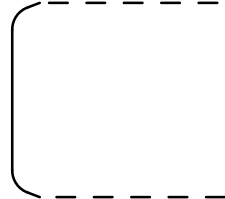

1747

BB-61747-0^{II}

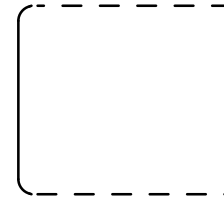

1756

AA-61756-0^{III}



1805

AA-61805-0^{II}



1903

AA-61903-0^{III}



1973

AA-61973-0^{III}

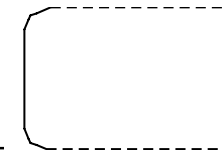

2198

AA-62198-0^{III}



2360

FAB-62360-0^{III}



2455

AA-32455-0^{II}

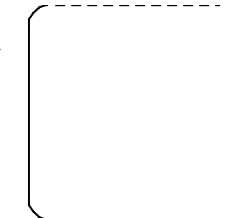

2457

BB-32457-0^{III}

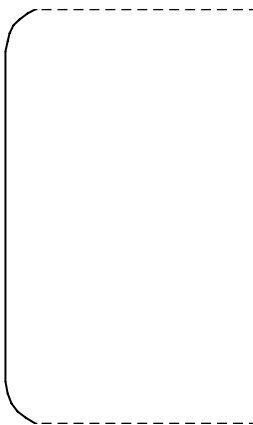

2475

CC-32475-0^{IV}

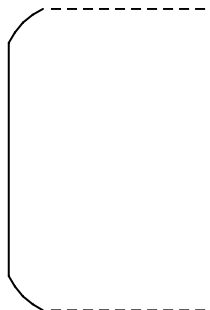

2483

CC-62483-0^{III}

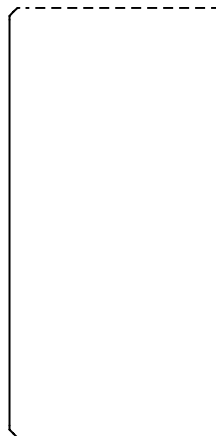

2486

CC-32486-0^{IV}



2495

CC-32495-0^{IV}

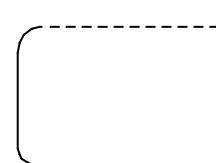

2547

AA-62547-0^{II}

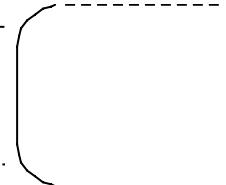

2579

AA-62579-0^{II}

CORNER ROUND

Symmetric Dual Radius

2581

AA-62581-0^{III}

CORNER ROUND

Asymmetric Dual Radius

0581

AA-60581-0^{III}

0715

AA-60715-0^{IV}

0886

BB-60886-0^{III}

0962

AA-60962-0^{III}

1365

BB-61365-30^{III}

1613

BB-61613-0^{III}

1898

AA-61898-15^{III}

1942

AA-61942-0^{III}

1955

AA-61955-0^{III}

2089

AA-32089-0^{III}

2199

FAB-62199-0^{VI}

2237

FBB-62237-0^{III}

2253

FBB-62253-0^{IV}

2456

FBC-62456-0^{III}

2589

FAB-72589-0^{VI}

CORNER ROUND

Radius Face-Up

0090

AA-60090-5^I

0092

AA-60092-22^I

0107

AA-60107-20^I

0110

AA-60110-15^I

0154

BB-60154-22^{III}









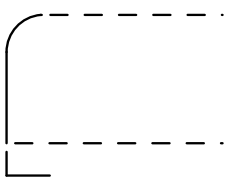
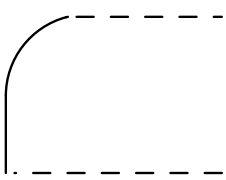
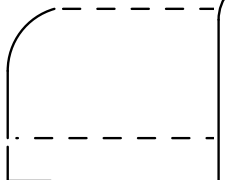
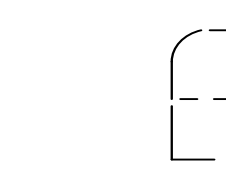
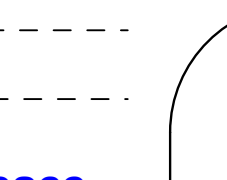

0167

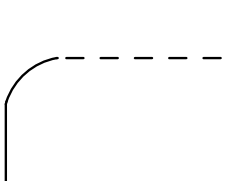
AA-60167-25^I

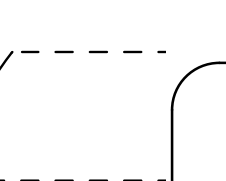
TURBOSAND

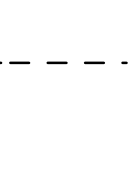
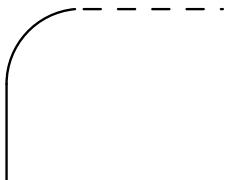
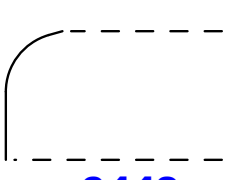
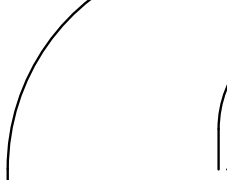
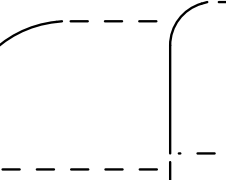
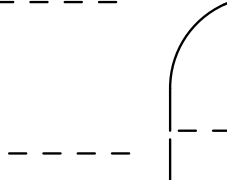
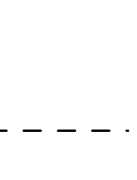
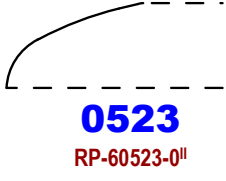
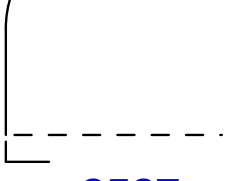
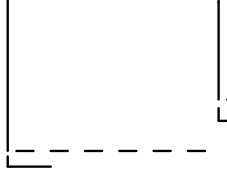
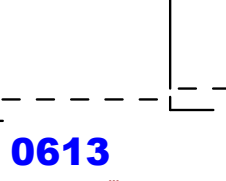
Turbosand Abrasive Sales
2350 Barney Street, Anderson, CA 96002 USA
Phone: (530) 378-6891 Toll Free
1-877-348-8726

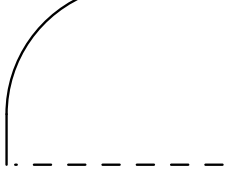
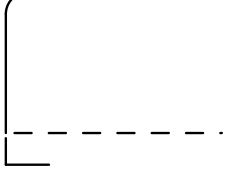
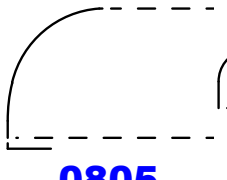
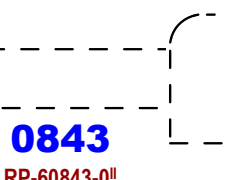
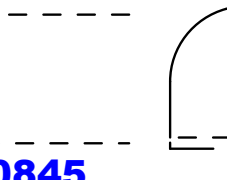
Page 11
7/7/2011

 0226 AA-60226-0 ^{II}	 0247 AA-60247-0 ^{II}	 0250 AA-60250-0 ^{III}	 0255 BB-60255-0 ^{III}	 0260 AA-60260-0 ^{II}	 0282 BB-60282-35 ^{III}
 0323 BB-60323-0 ^{III}	 0360 AA-60360-0 ^{III}	 0371 CC-60371-0 ^{III}	 0372 AA-60372-0 ^{II}	 0386 FBA-60386-0 ^{II}	 0387 FBA-60387-0
 0398 AA-60398-20 ^{III}	 0449 AA-60449-45 ^{II}	 0467 CC-60467-30 ^{II}	 0495 BB-60495-40 ^{II}	 0509 AA-60509-0 ^{II}	 0519 FCC-60519-0 ^{III}
 0523 RP-60523-0 ^{II}	 0567 BB-60567-15 ^{II}	 0613 BB-60613-0 ^{III}	 0613 AA-60628-0 ^{III}	 0703 AA-60703-0 ^{III}	 0714 BB-60714-0 ^{IV}
 0751 FBB-60751-0 ^{II}	 0790 AA-60790-0 ^{IV}	 0805 AA-60805-30 ^{II}	 0843 RP-60843-0 ^{II}	 0845 AA-60845-0 ^{II}	 0875 AA-60875-20 ^{II}

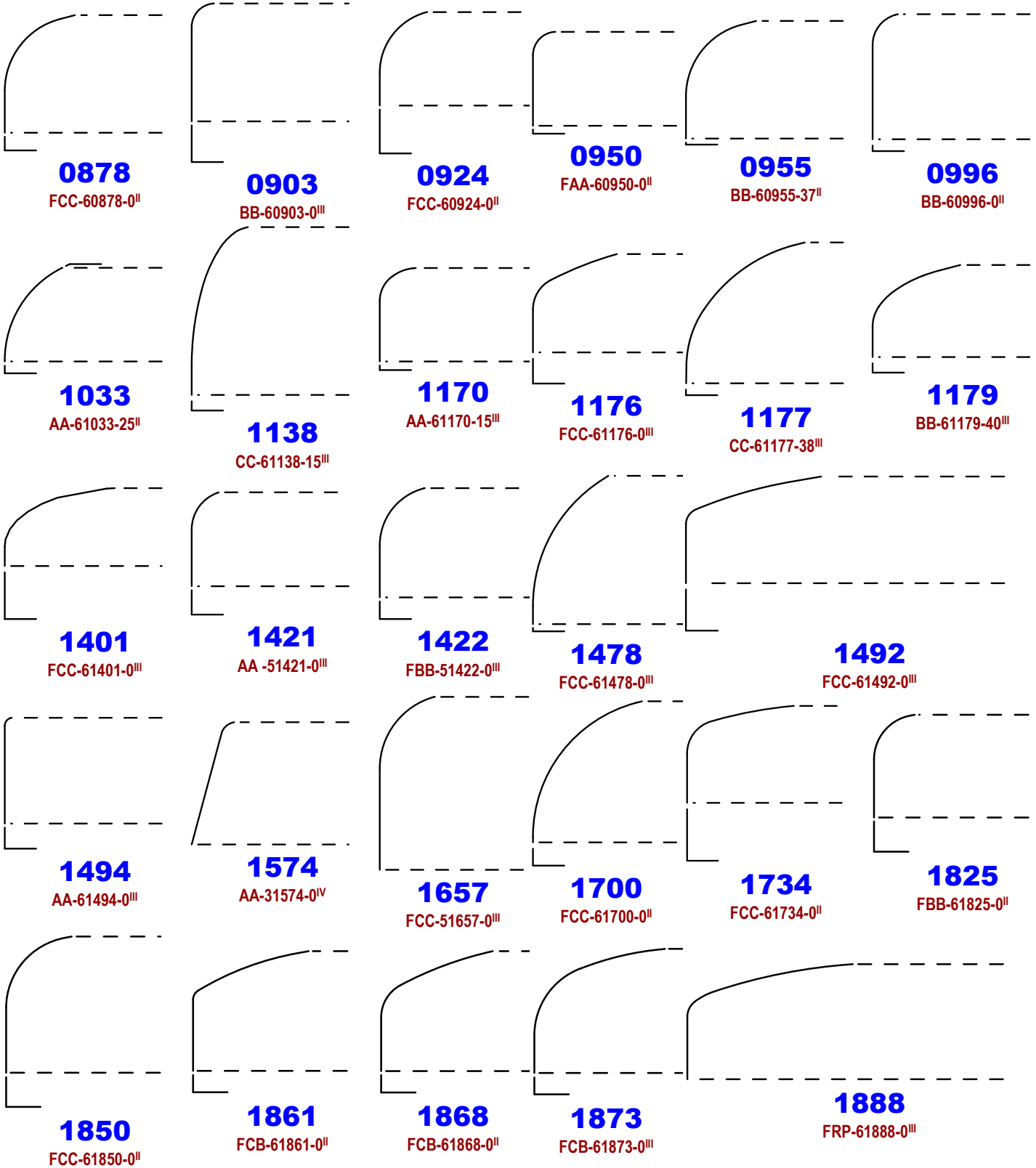

CORNER ROUND

Radius Face-Up

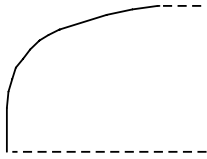

2109

FCB-62109M-0^{III}



2010

AA-62010-0^{II}

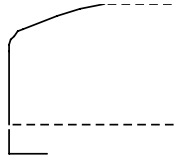

2115

FCB-62115M-0^{II}

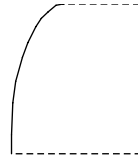

2132

FBC-62132-0^{II}



2134

FBB-62134-0^{III}

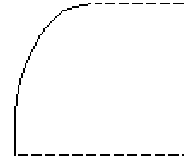

2142

FBB-62142-0^{II}



2392

FTA-42392-0^{III}

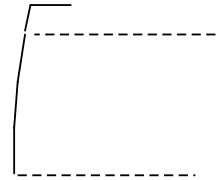

2395

FAB-72395M-0^{II}

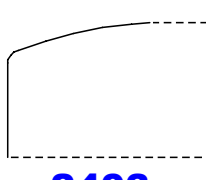

2403

FCB-72403-0^{III}

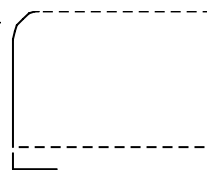

2454

AA-62454-0^{III}

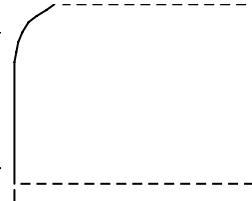

2477

AA-62477-0^{III}

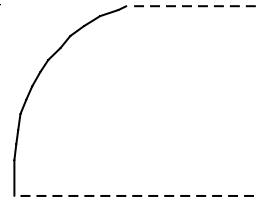

2484

FBB-62484-0^{II}

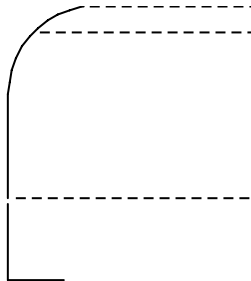

2559

FBC-62559-0^{II}

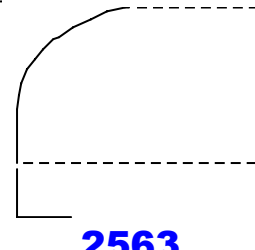

2563

FBB-62563-0^{II}

CORNER ROUND

Radius Face-Down

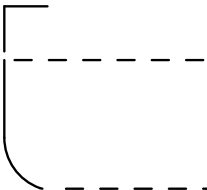

0194

AA-60194-0^{II}

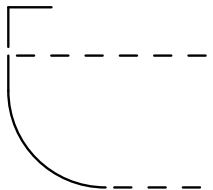

0496

FBB-60496-0^{III}

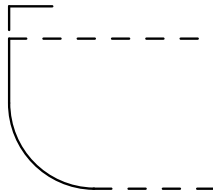

0502

FBB-60502-0^{II}

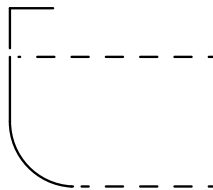

0538

FBB-60538-0^{III}

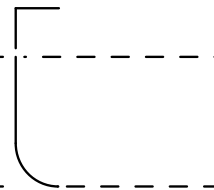

0539

FBB-60539-0^{III}

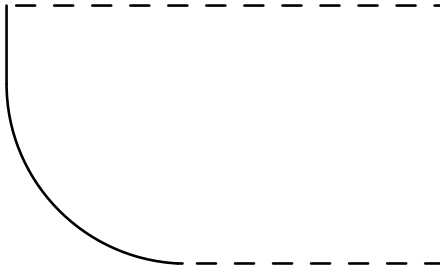

0601

FCC-60601-0^{III}

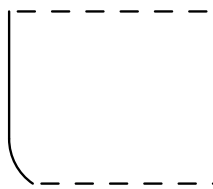

0731

FCC-60731-0^{II}

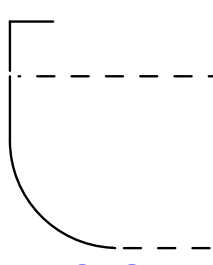

0735

FCC-60735-0^{II}

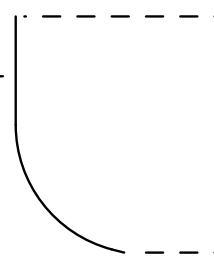

0774

FCC-60774-0^{II}

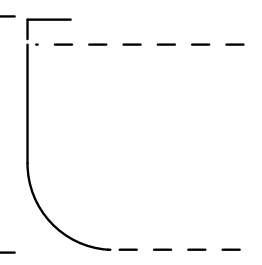

0901

FCC-60901-0^{III}

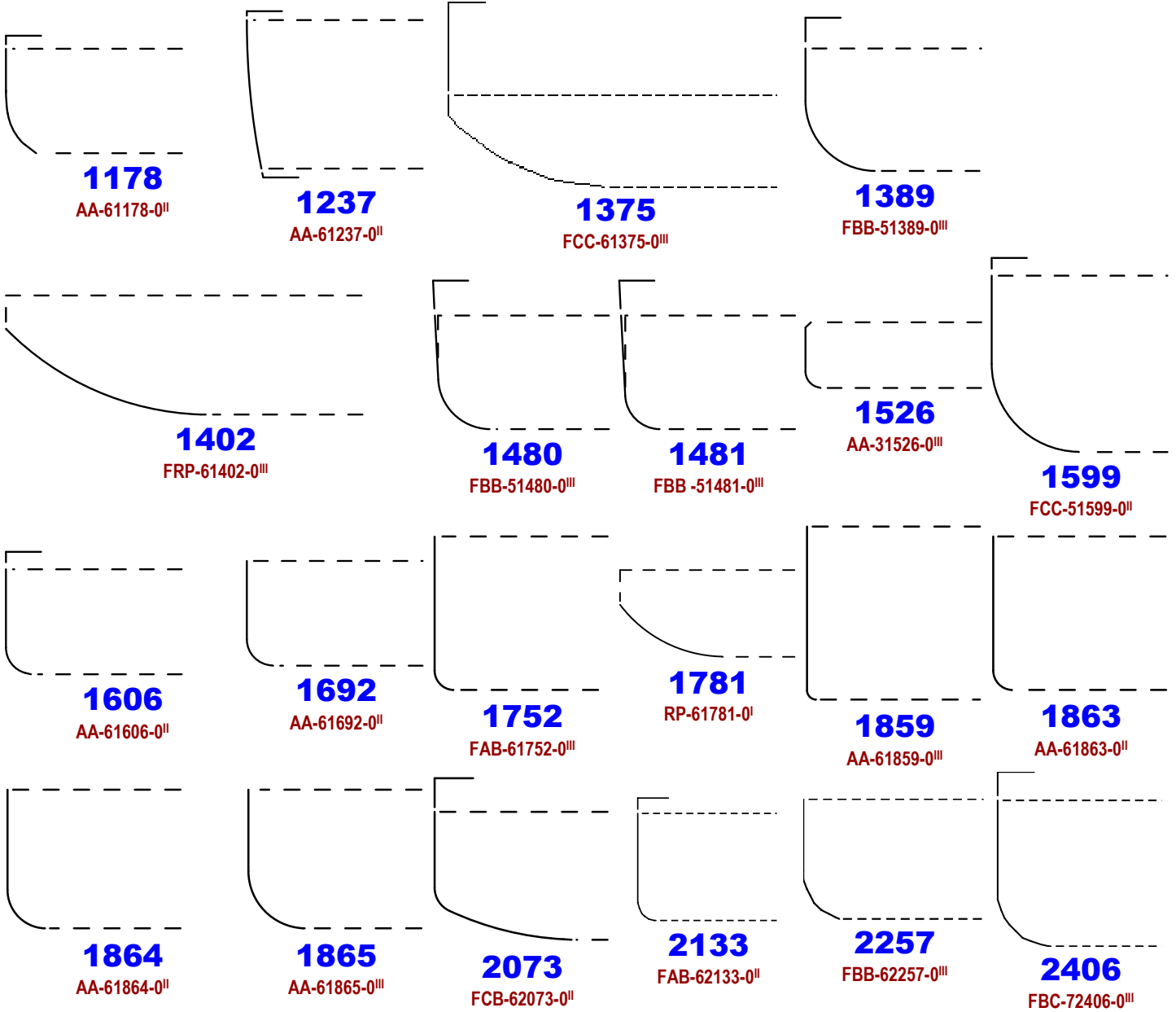

CORNER ROUND

Radius Face-Down

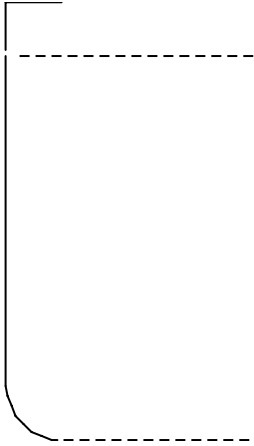

2504

CC-62504-0^{III}

COVE EDGE

Face-up

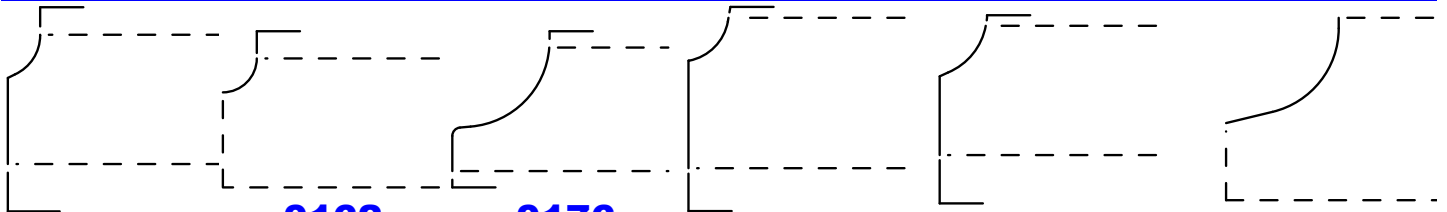

0080

AA-60080-15^{II}

0162

AA-60162-25^{II}

0176

AA-60176-25^{II}

0212

AA-60212-10^{III}

0217

AA-60217-15^{II}

0233

AA-60233-25^{II}

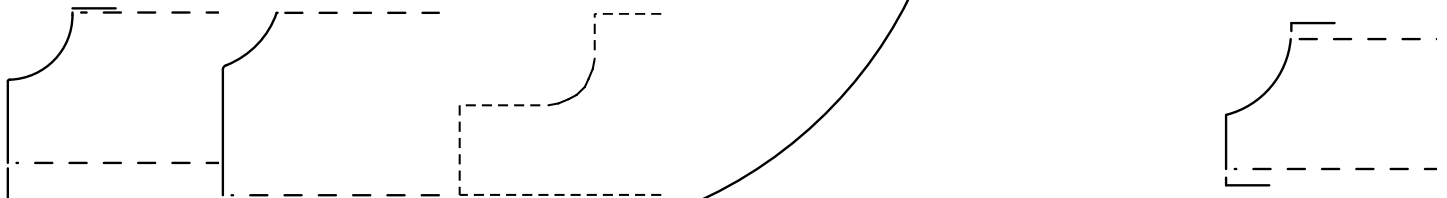

0346

AA-60346-15^{II}

0353

AA-60353-15^{II}

0403

AA-60403-45^{II}

0475

CC-60475-43^{II}

0529

AA-60529-0^{II}

COVE EDGE

Face-up

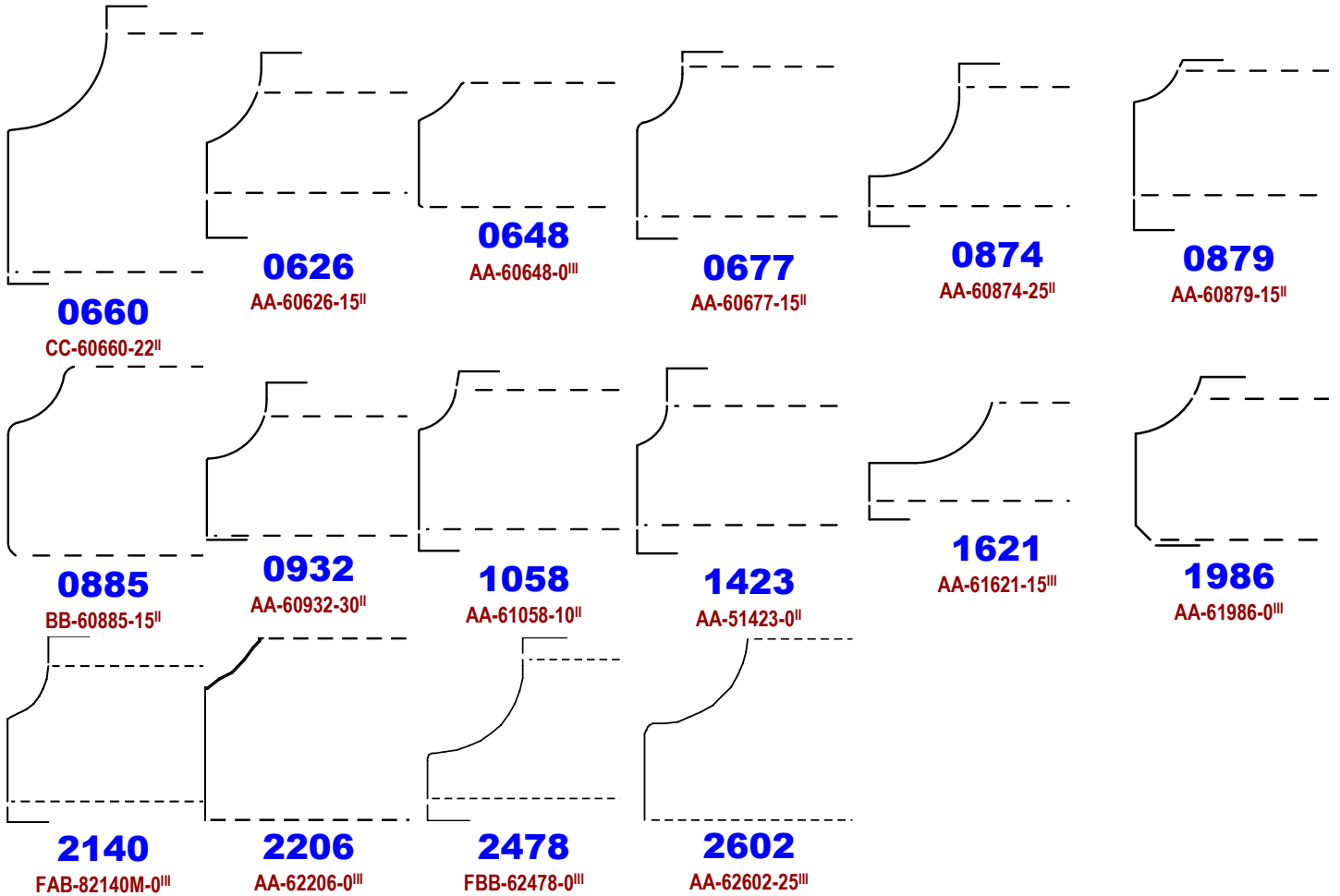

COVE EDGE

Face-Down

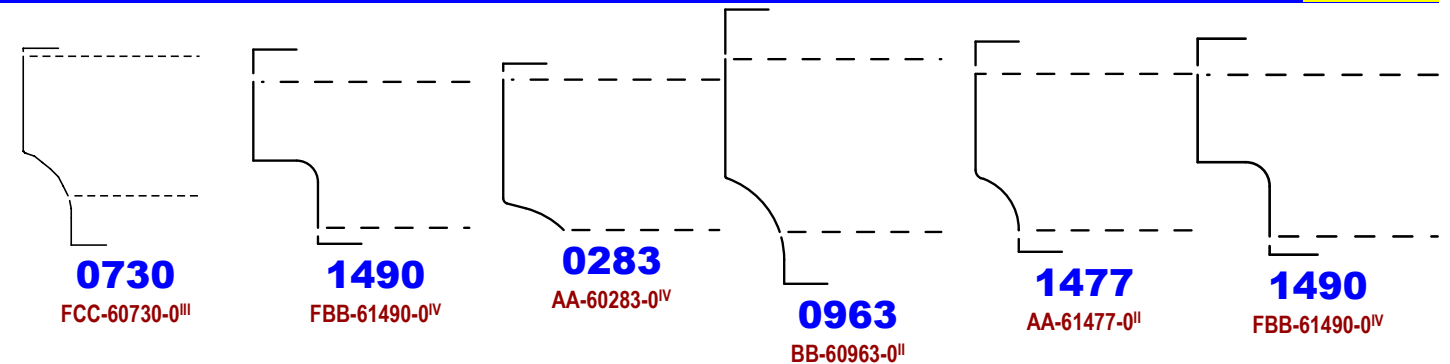

COVE EDGE

Dual

COVE EDGE

Dual

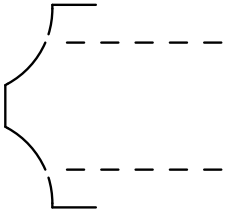

0216

AA-60216-0^I

DOOR/DRAWER PULL

Corner-Round with Bevel Pull

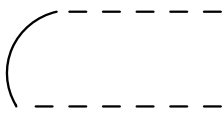

0332

AA-60332-10^{III}

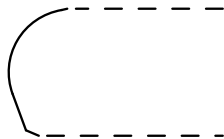

0740

AA-60740-20^{II}



0761

AA-60761-20^{III}

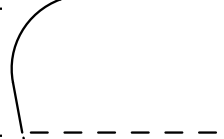

0850

AA-60850-10^{III}

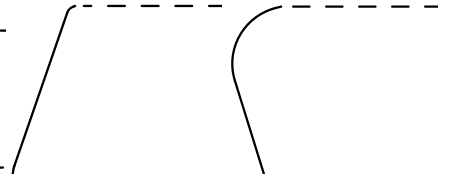

0900

BB-60900-19^{III}

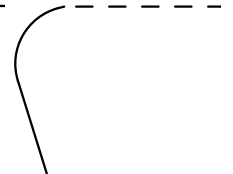

1121

BB-61121-5^{III}

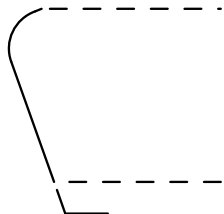

1297

BB-61297-0^{III}

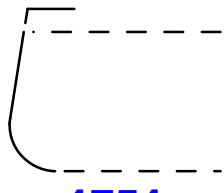

1751

AA-61751-0^{IV}

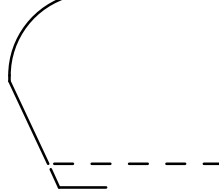

1802

BB-61802-10^{III}

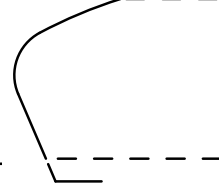

1862

FBB-61862-0^{III}

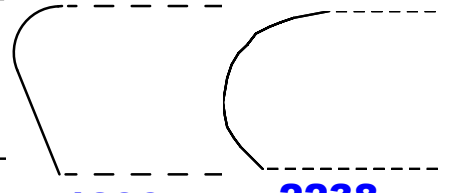

1890

FAB-61890-0^{III}

2238

FBB-62238-0^{III}

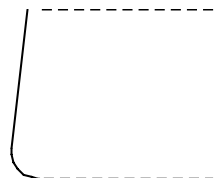

2279

FBB-62279-0^{IV}

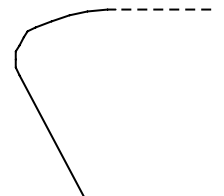

2440

FCC-62440-0^{IV}

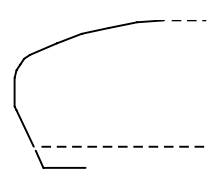

2444

FCC-62444-0^V

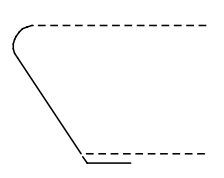

2493

FCC-62493-0^{II}



2528

AA-62528-0^{III}

DOOR/DRAWER PULL

Bevel Top with Bevel Pull

DOOR/DRAWER PULL

Bevel Top with Bevel Pull

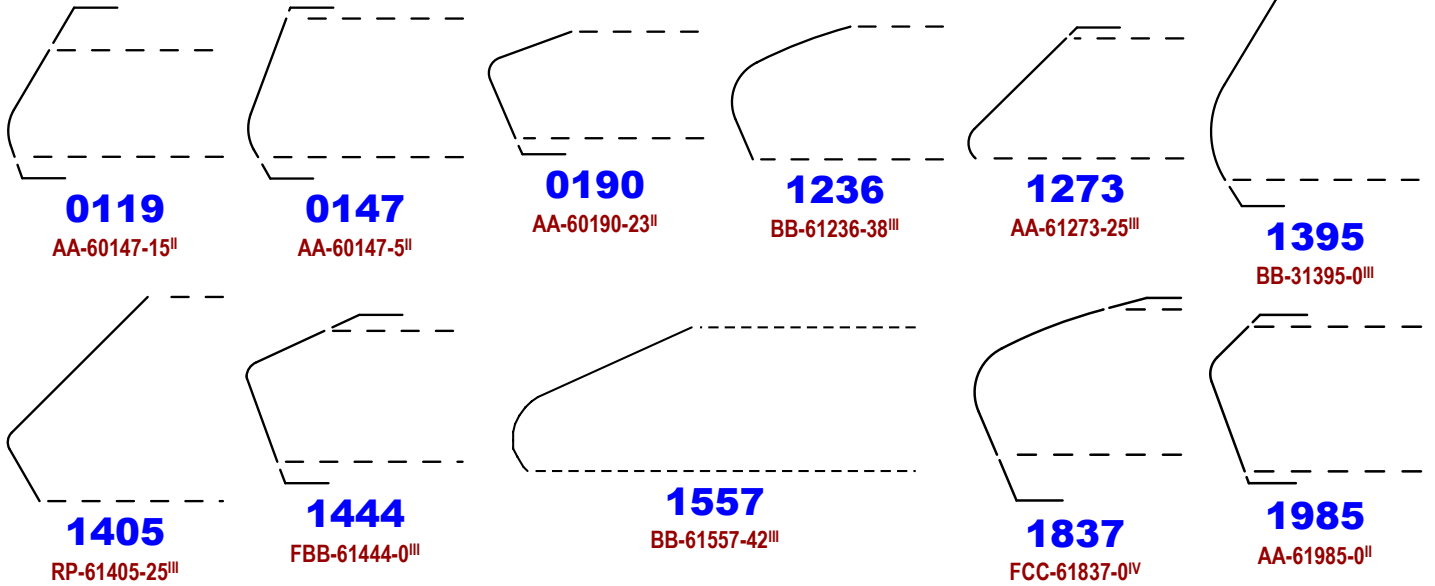

DOOR/DRAWER PULL

2-Curve with Bevel Pull

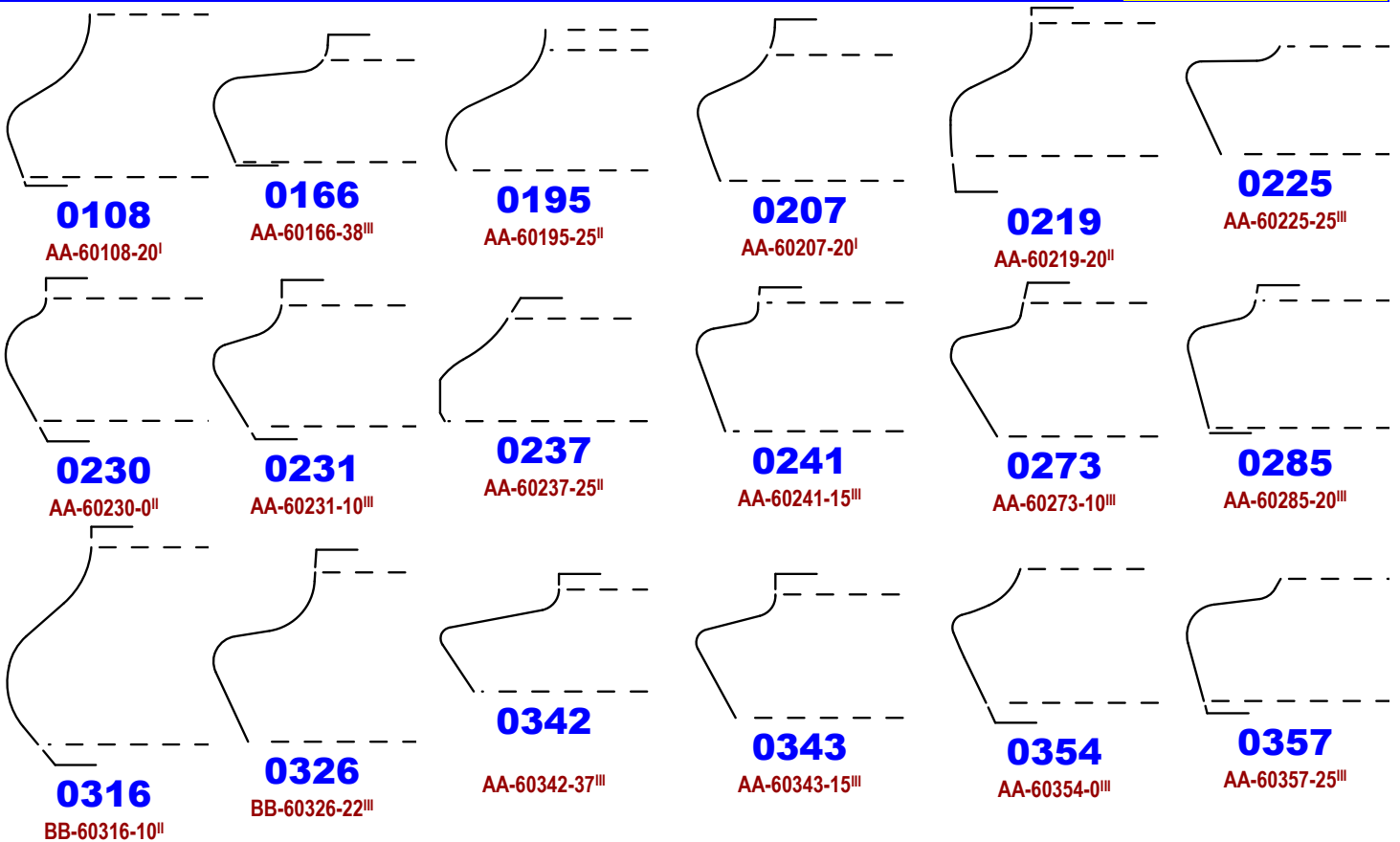

DOOR/DRAWER PULL

2-Curve with Bevel Pull

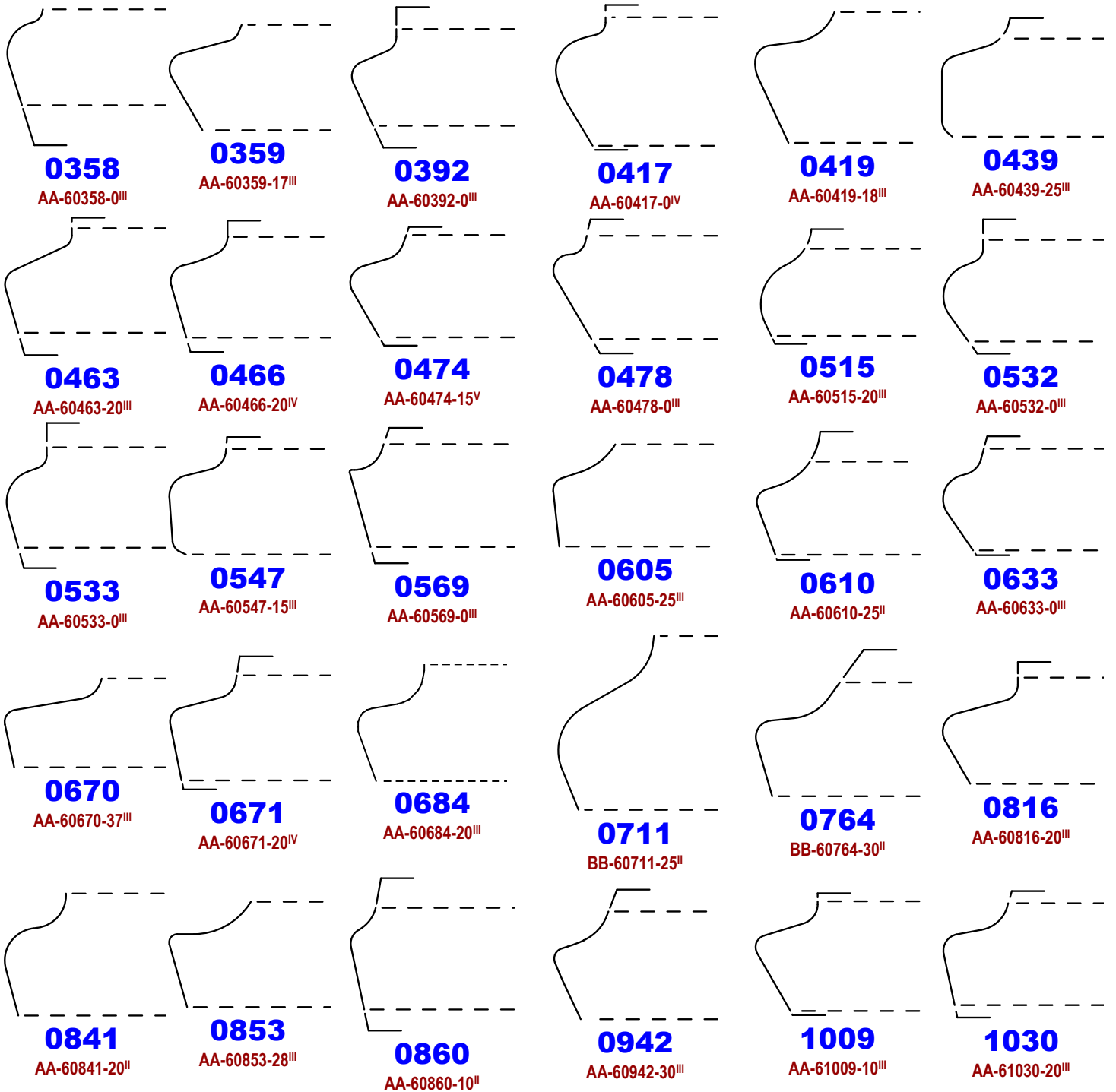

DOOR/DRAWER PULL

2-Curve with Bevel Pull

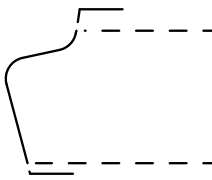

1059

AA-61059-15^{III}

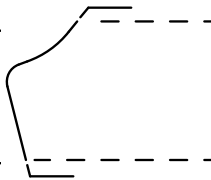

1065

AA-61065-17^{II}

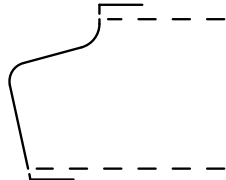

1158

AA-61158-20^{III}

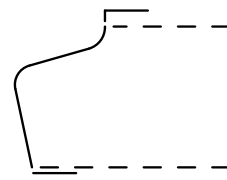

1212

AA-61212-25^{III}

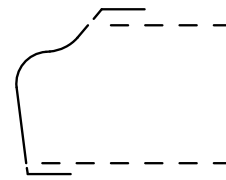

1250

AA-61250-20^{III}

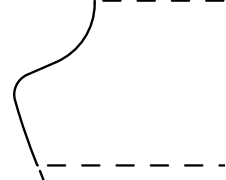

1425

AA-51425-0^{II}

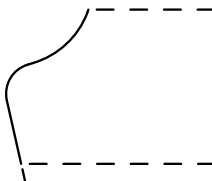

1447

AA-61447-20^{II}

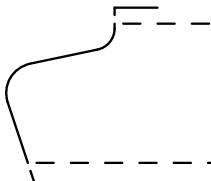

1460

AA-61460-25^{IV}

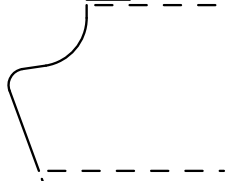

1468

AA-61468-0^{III}

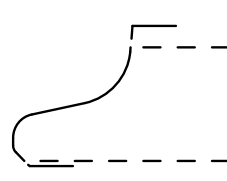

1485

FBB-61485-0^{IV}

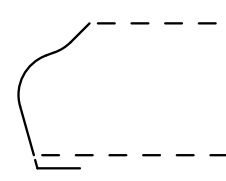

1505

AA-61505-0^{II}

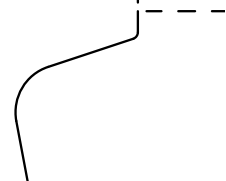

1544

BB-61544-30^V

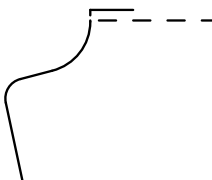

1545

AA-61545-20^{II}

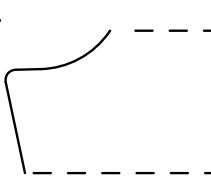

1567

AA-61567-28^{III}

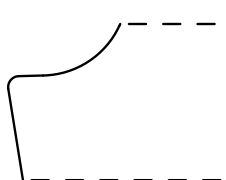

1583

AA-61583-28^{II}

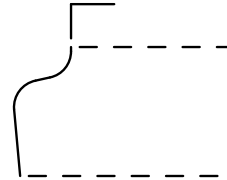

1610

AA-61610-15^{IV}

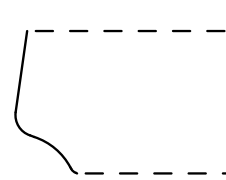

1616

AA-61616-0^{II}

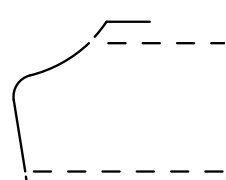

1647

AA-61647-25^{II}

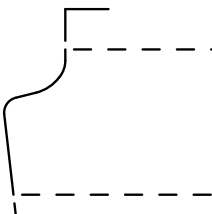

1672

AA-61672-0^{III}

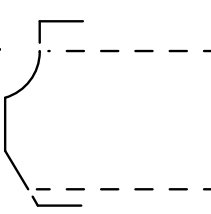

1673

AA-61673-0^{III}

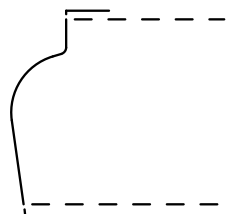

1677

AA-61677-0^{IV}

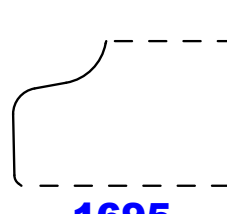

1695

AA-61695-20^{III}

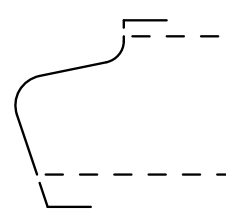

1708

FBB-61708-0^{IV}

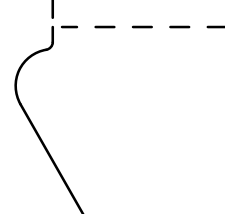

1758

BB-61758-0^{II}

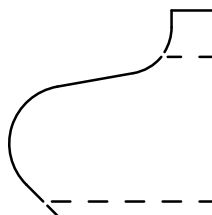

1779

FCC-61779-0^V

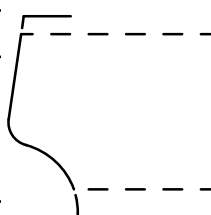

1780

AA-61780-0^{II}

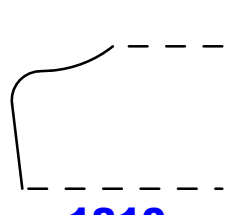

1810

AA-61810-25^{II}

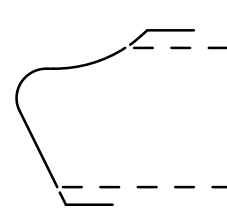

1828

FBB-61828-0^V

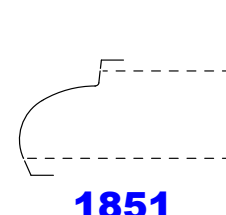

1851

FCC-61851-0^V

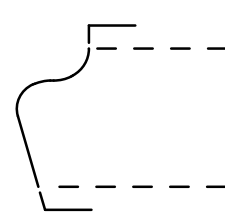

1854

AA-61854-0^{III}

DOOR/DRAWER PULL

2-Curve with Bevel Pull

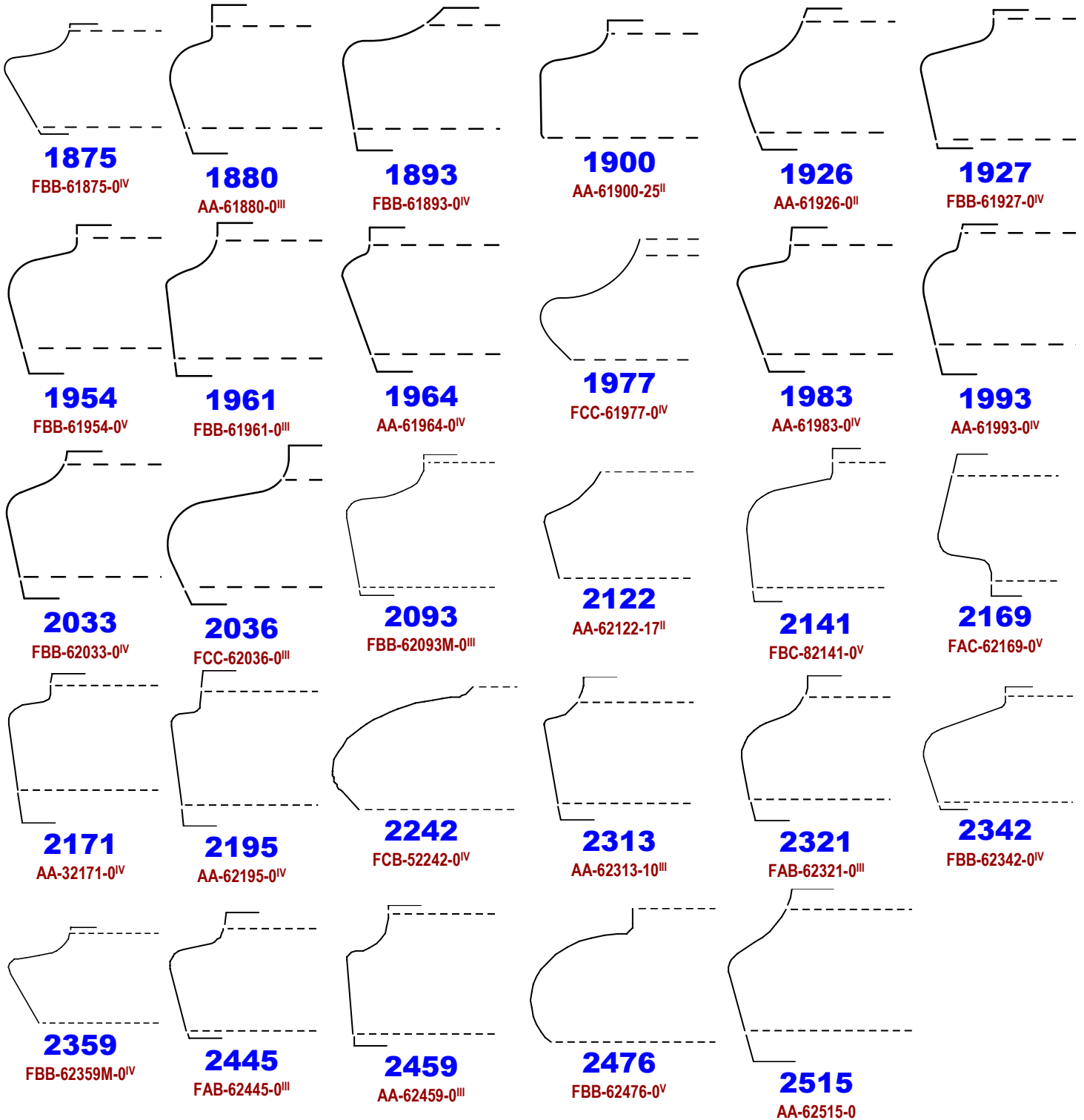

DOOR/DRAWER PULL

3-Curve with Bevel Pull

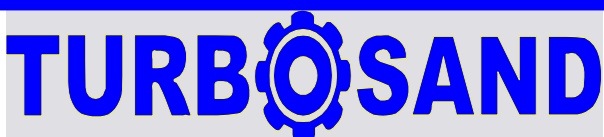

Turbosand Abrasive Sales
2350 Barney Street, Anderson, CA 96002 USA
Phone: (530) 378-6891 Toll Free
1-877-348-8726

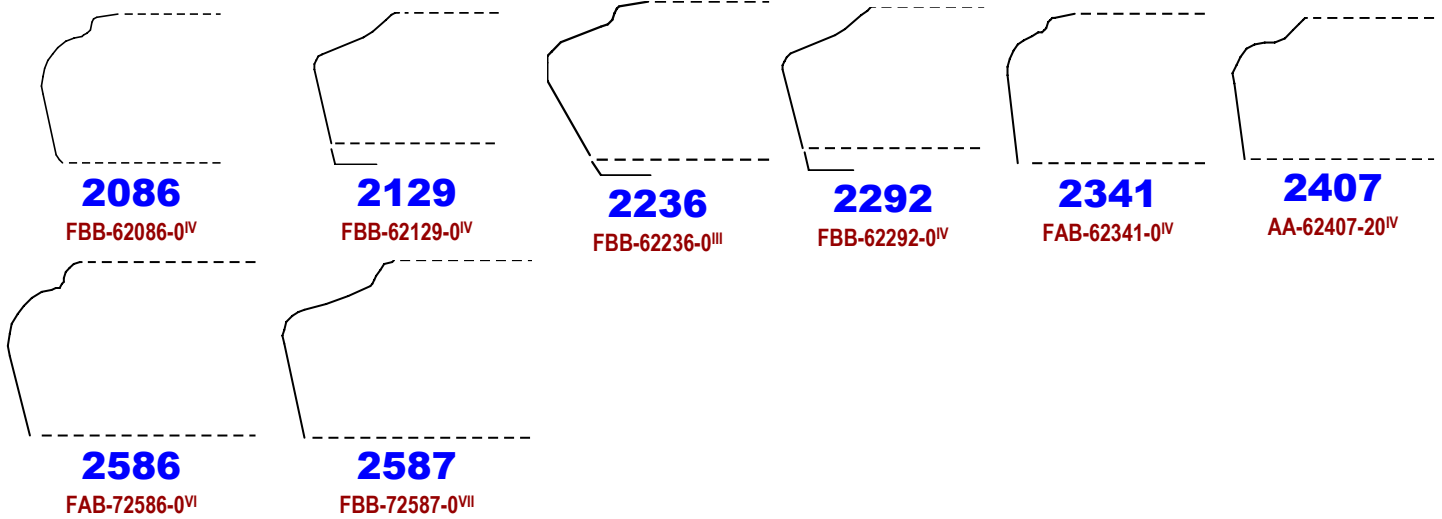

DOOR/DRAWER PULL
4-Curve with Bevel Pull

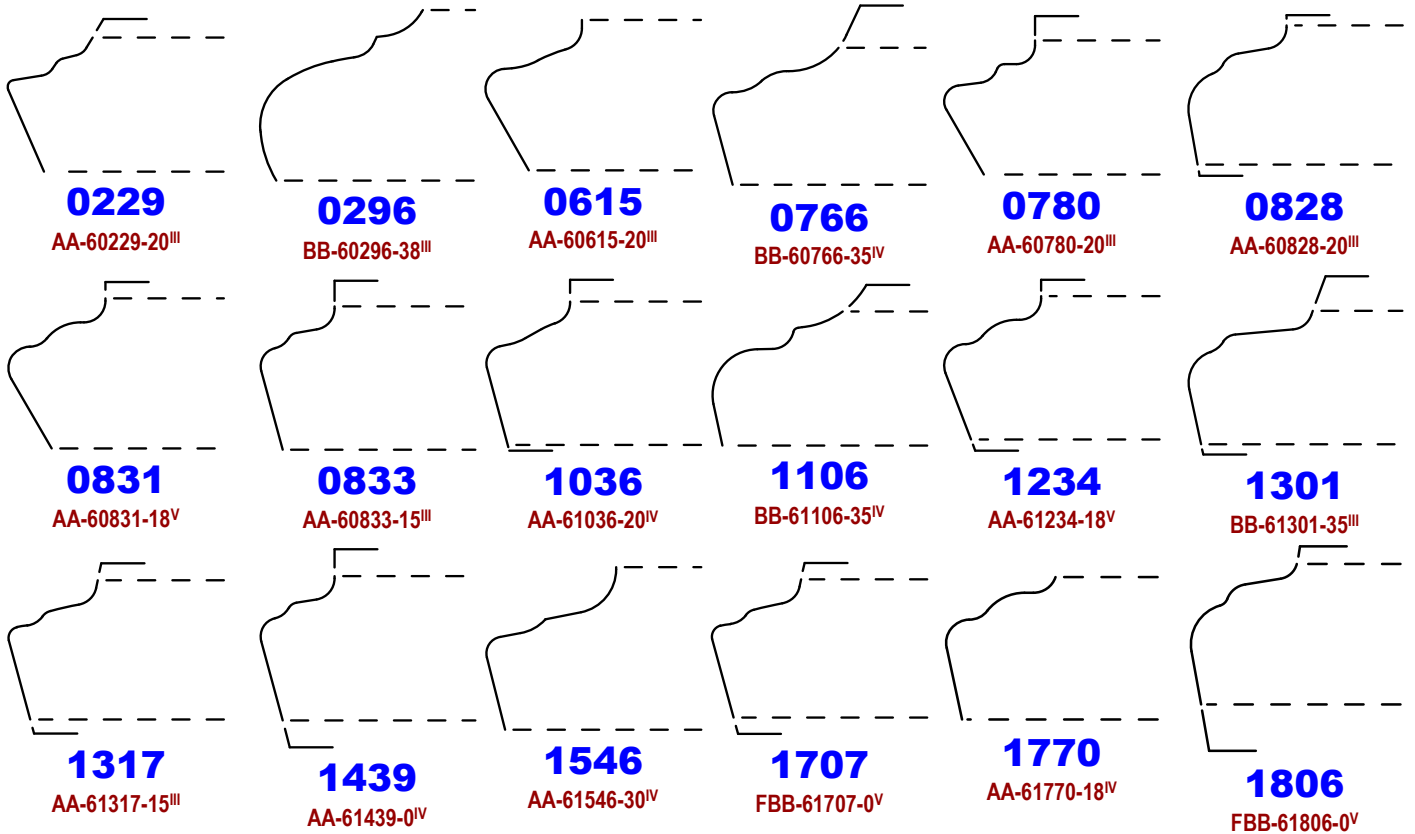

DOOR/DRAWER PULL

4-Curve with Bevel Pull

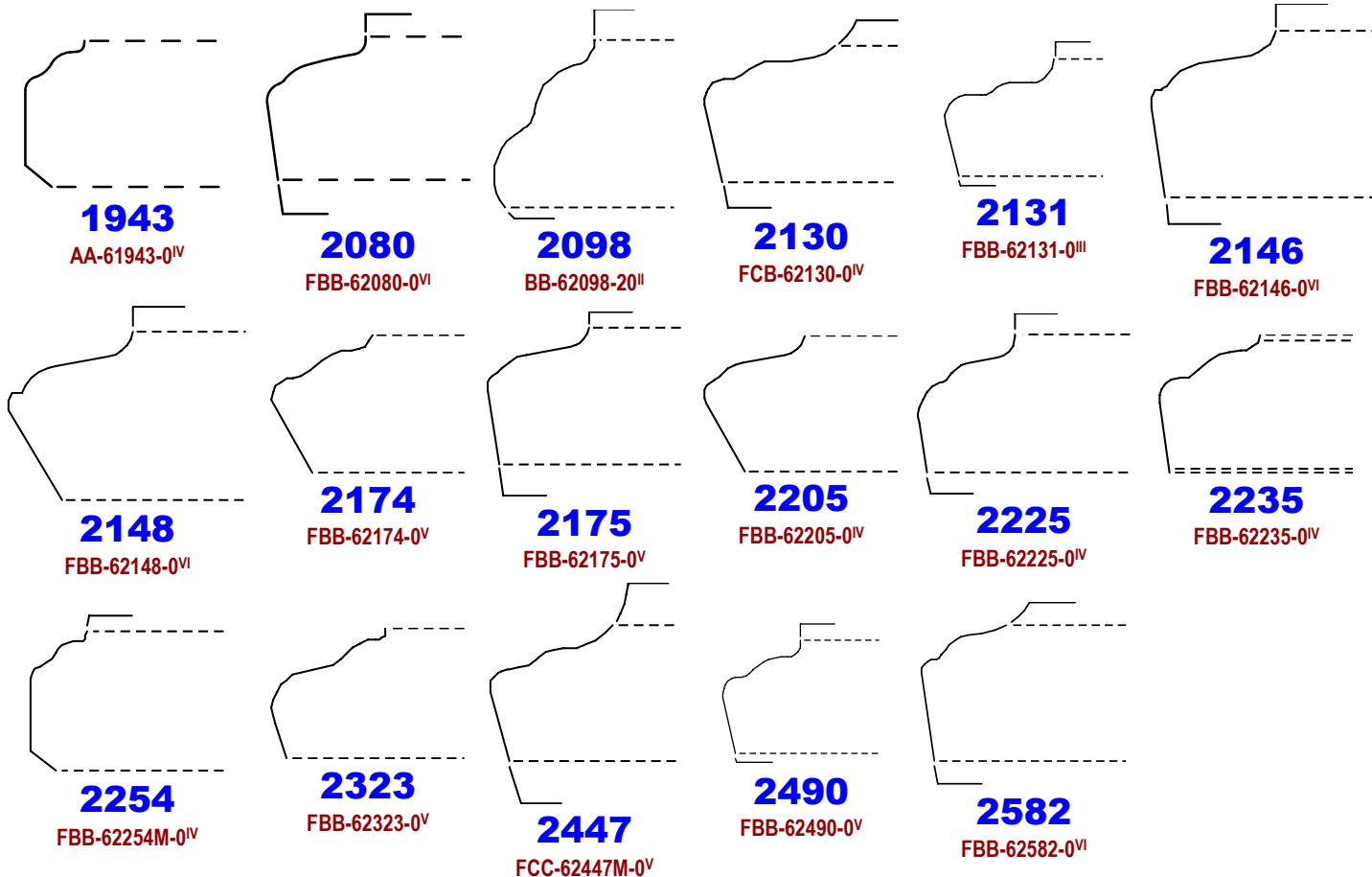

DOOR/DRAWER PULL

5-Curve with Bevel Pull

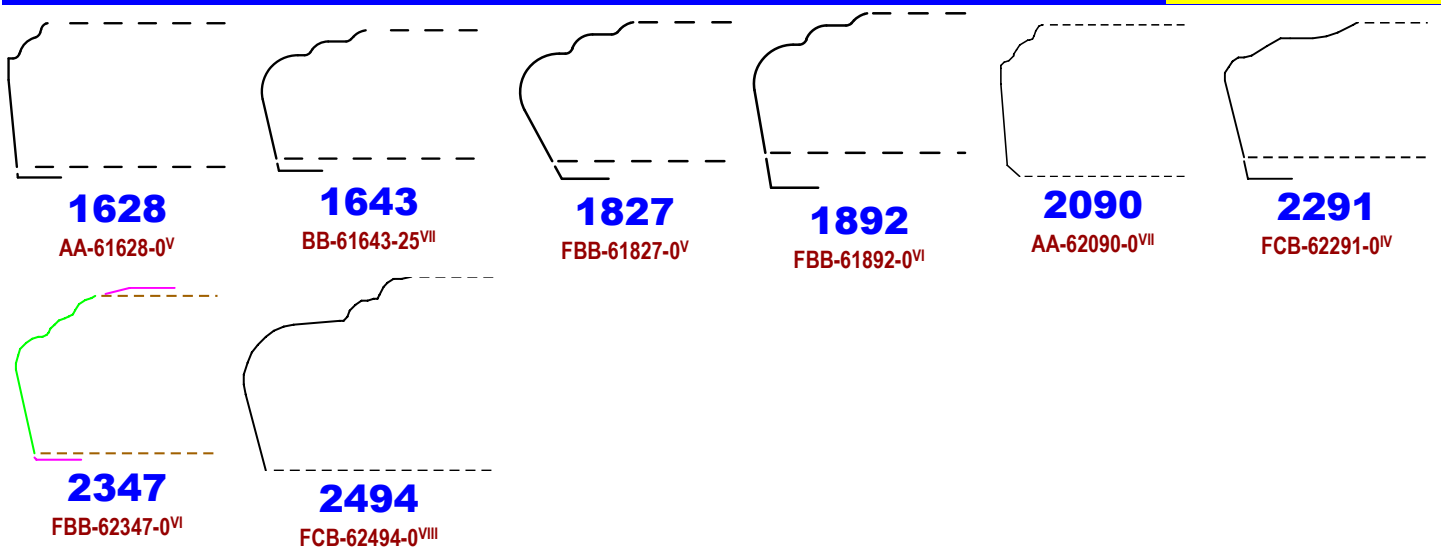

DOOR/DRAWER PULL

6-Curve with Bevel Pull

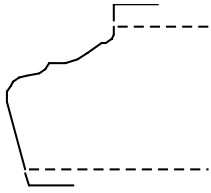

2285

FBB-62285-0^V

DOOR/DRAWER PULL

7-Curve with Bevel Pull

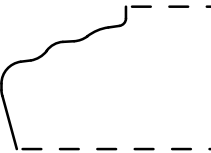

1979

AA-61979-35^V

DOOR/DRAWER PULL

Bevel Top with Concave Pull

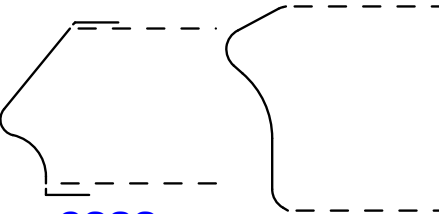

0838

AA-60838-10^{II}

1383

BB-61383-0^{III}

DOOR/DRAWER PULL

Square Edge with Concave Pull

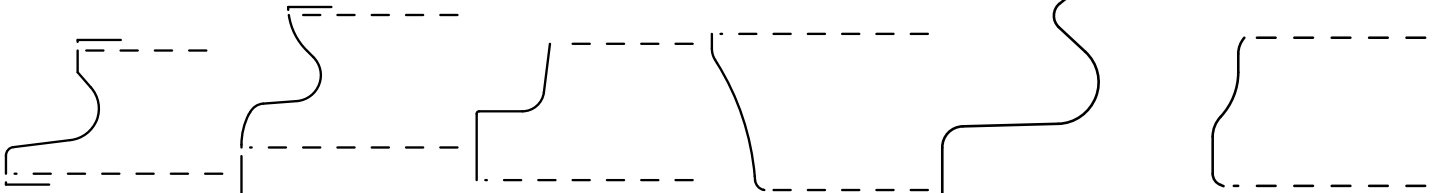

0177

AA-60177-25^{III}

0287

AA-60287-15^{III}

0911

AA-60911-10^{III}

1141

FBB-61141-0^{II}

1676

BB-61676-40^{III}

1894

AA-61894-0^{II}

DOOR/DRAWER PULL

Square Edge with Concave Pull

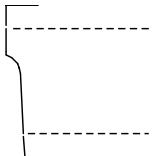

2128

AA-62128-0^{III}

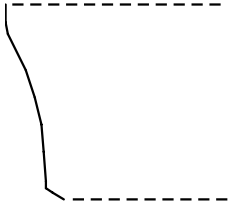

2135

FAB-62135-0^{III}

DOOR/DRAWER PULL

Corner Round with Concave Pull

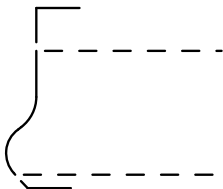

0546

AA-60546-0^{II}

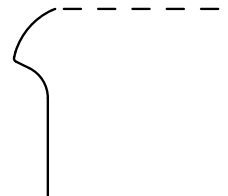

0552

AA-60552-0^{III}

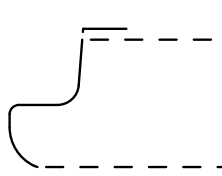

0560

AA-60560-15^{IV}

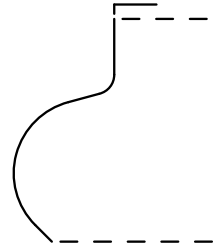

0570

BB-60570-20^{III}

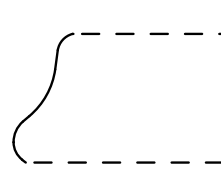

0659

AA-60659-22^{III}

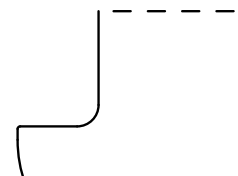

0793

AA-60793-20^{III}

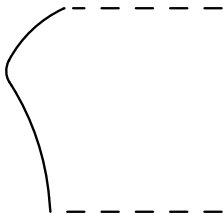

1140

BB-61140-7^{III}

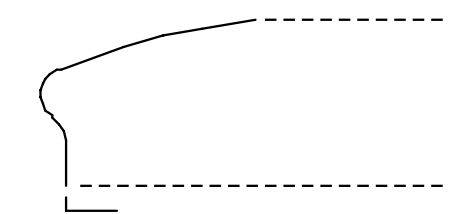

1491

FCC-61491-0^{IV}

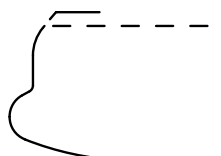

1595

FCC-61595-0^V

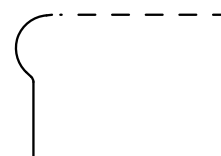

1644

AA-61644-15^{IV}

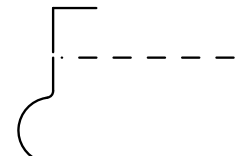

1670

AA-61670-0^{IV}

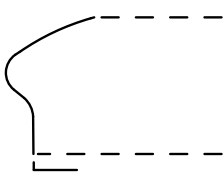

1703

BB-61703-28^{III}

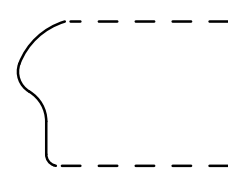

1895

AA-61895-0^{II}

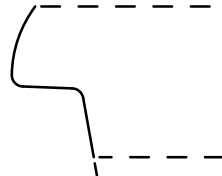

2003

FBB-62003-0^{VII}

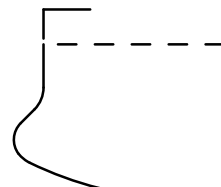

2074

FCB-62074-0^V

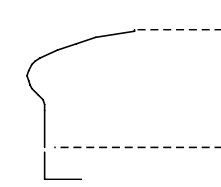

2116

FCB-62116M-0^{VI}

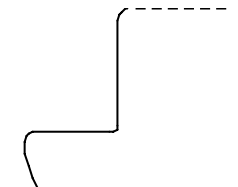

2276

FBC-62276-0^{VI}



2277

FBC-62277-0^{VI}

DOOR/DRAWER PULL

2-Curve with Concave Pull



Turbosand Abrasive Sales
2350 Barney Street, Anderson, CA 96002 USA
Phone: (530) 378-6891 Toll Free
1-877-348-8726

DOOR/DRAWER PULL

2-Curve with Concave Pull

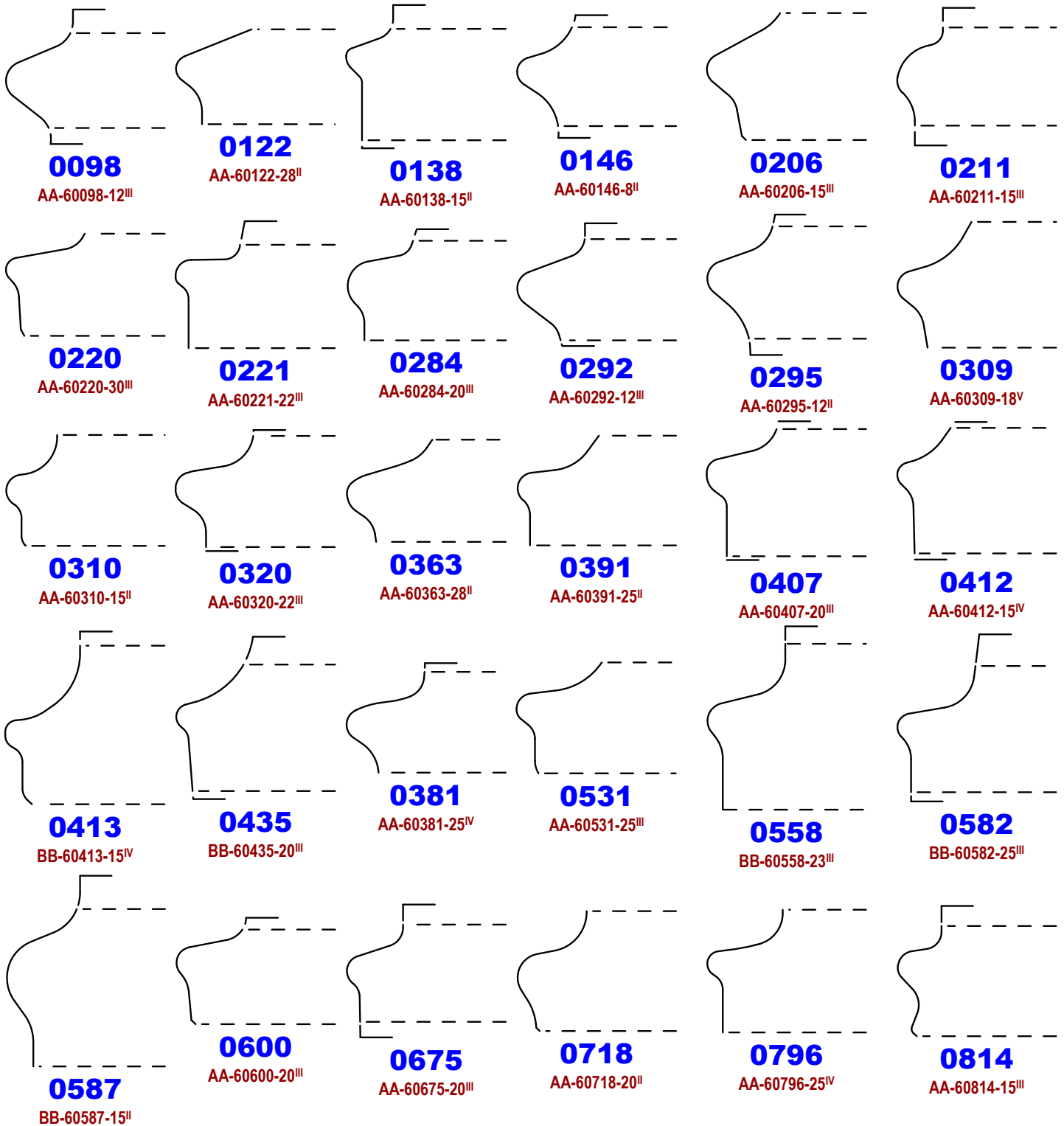

DOOR/DRAWER PULL

2-Curve with Concave Pull

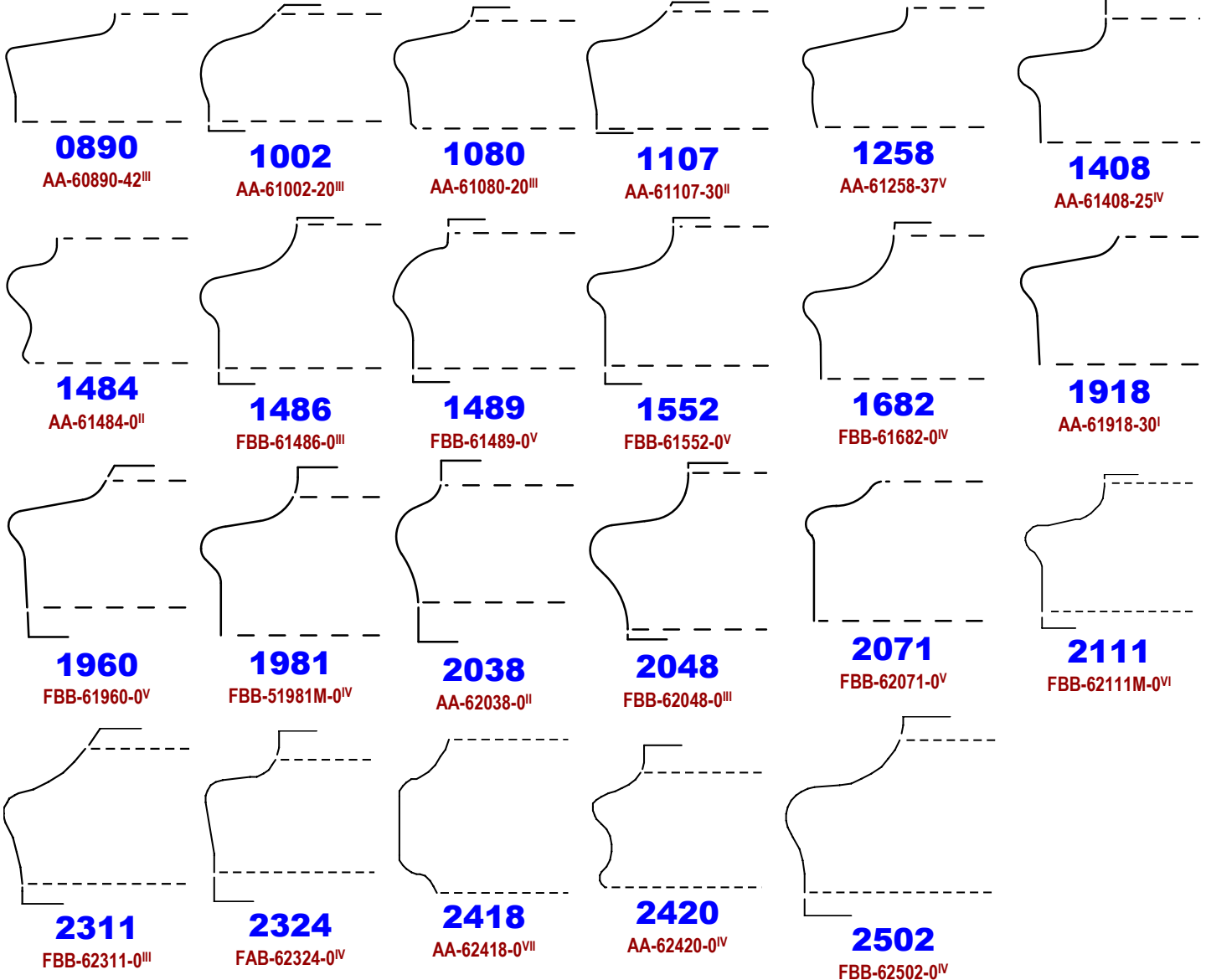

DOOR/DRAWER PULL

3-Curve with Concave Pull



DOOR/DRAWER PULL

4-Curve with Concave Pull

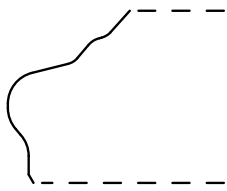

0210

AA-60210-30^{III}

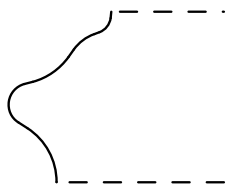

0317

AA-60317-17^{III}

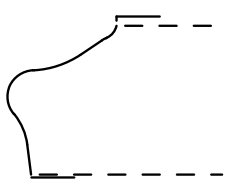

0586

AA-60586-30^{III}

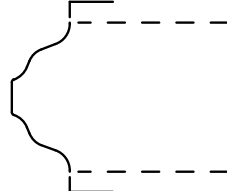

0892

AA-60892-0^{IV}

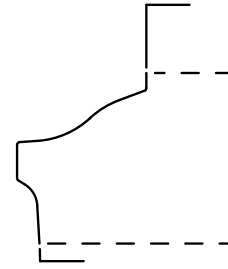

1407

BB-61407-30^V

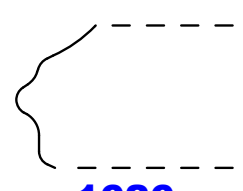

1626

AA-61626-15^V

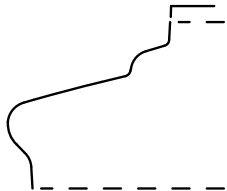

1716

BB-61716-40^V

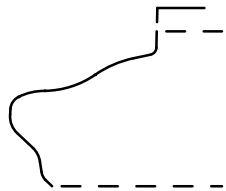

1739

BB-61739-35^{VI}

DOOR/DRAWER PULL

5-Curve with Concave Pull

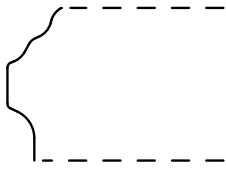

1122

AA-61122-15^V

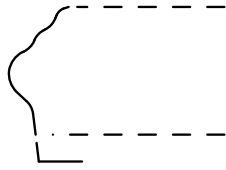

1713

AA-61713-10^V

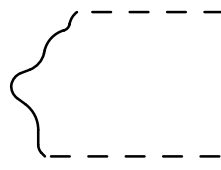

1896

FBB-61896-0^V

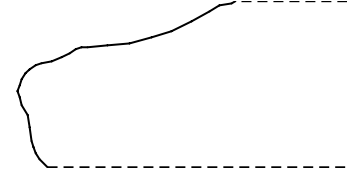

2530

FCB-62530-0^V

DOOR/DRAWER PULL

Corner Round with Convex Pull

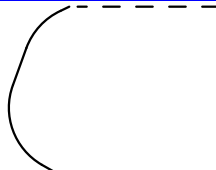

0905

BB-60905-5^{III}



1196

AA-61196-10^{III}

DOOR/DRAWER PULL

2-Curve with Convex Pull

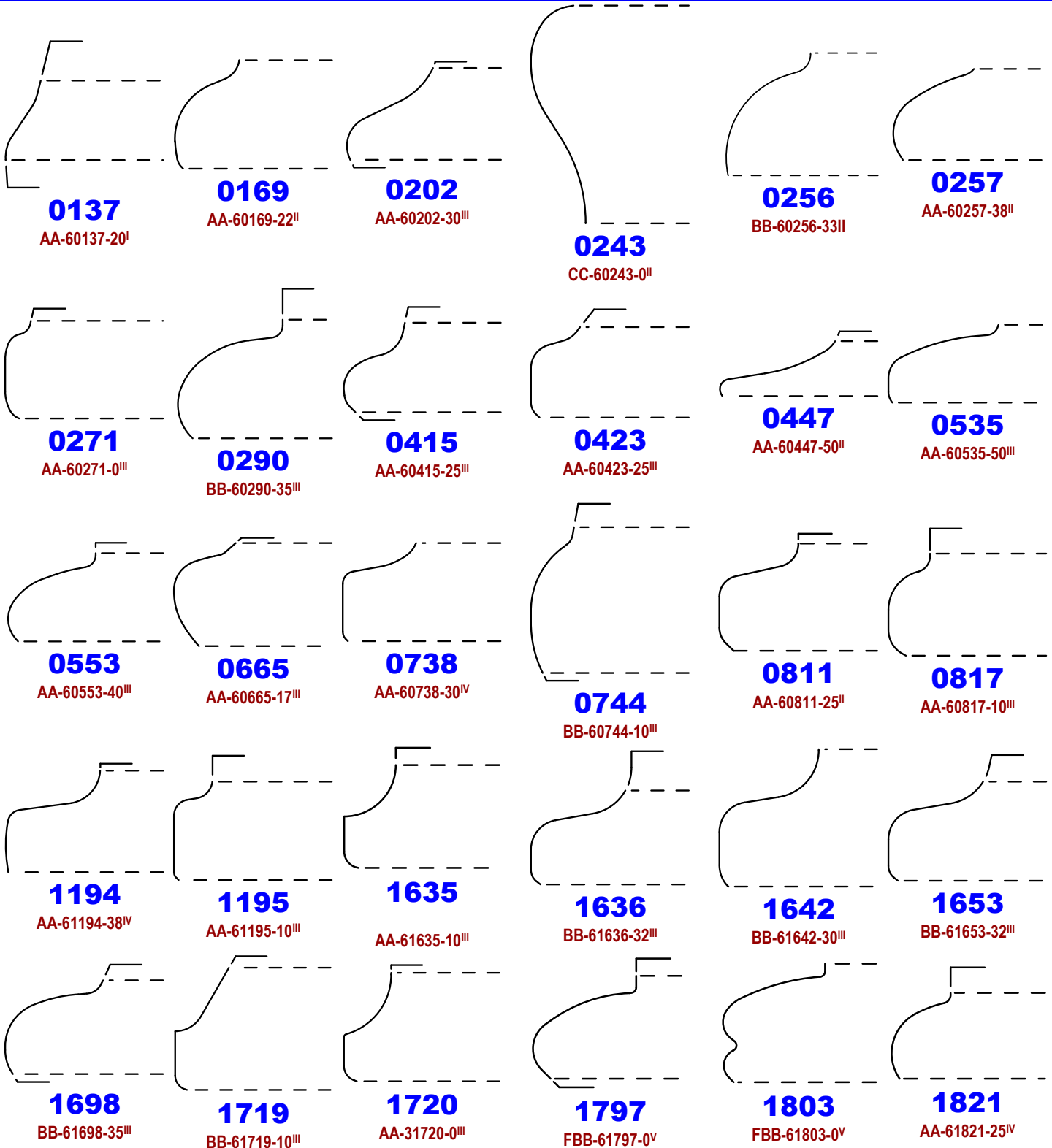

DOOR/DRAWER PULL

2-Curve with Convex Pull

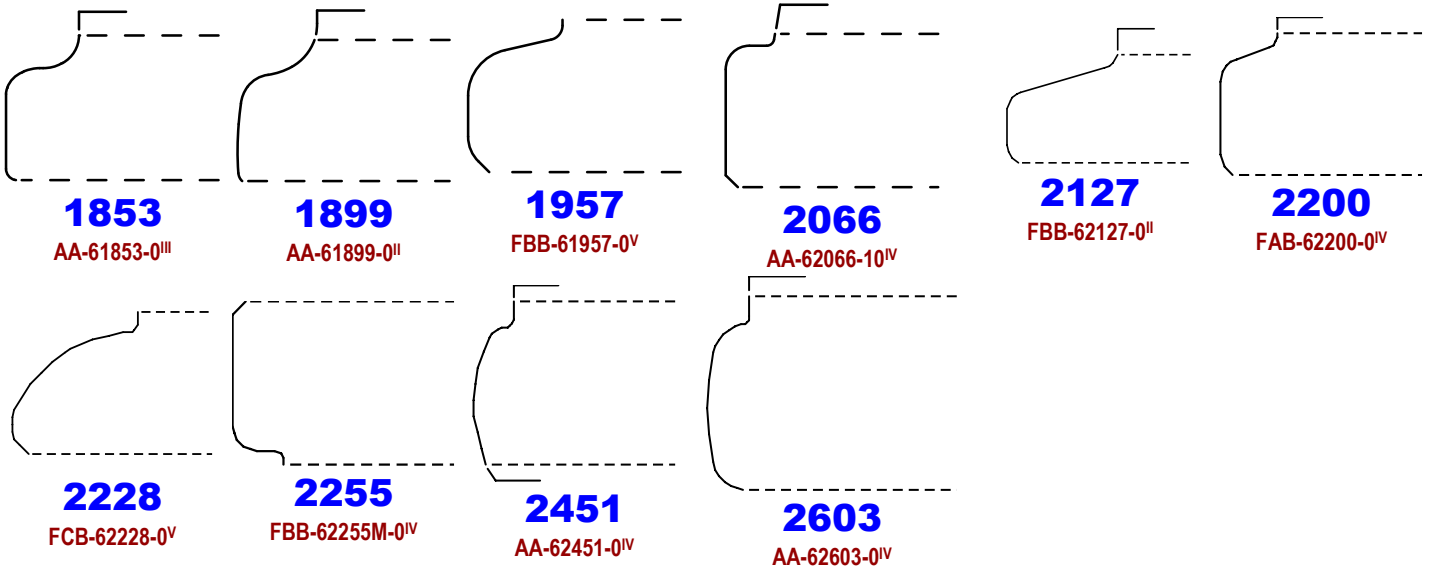

DOOR/DRAWER PULL

3-Curve with Convex Pull

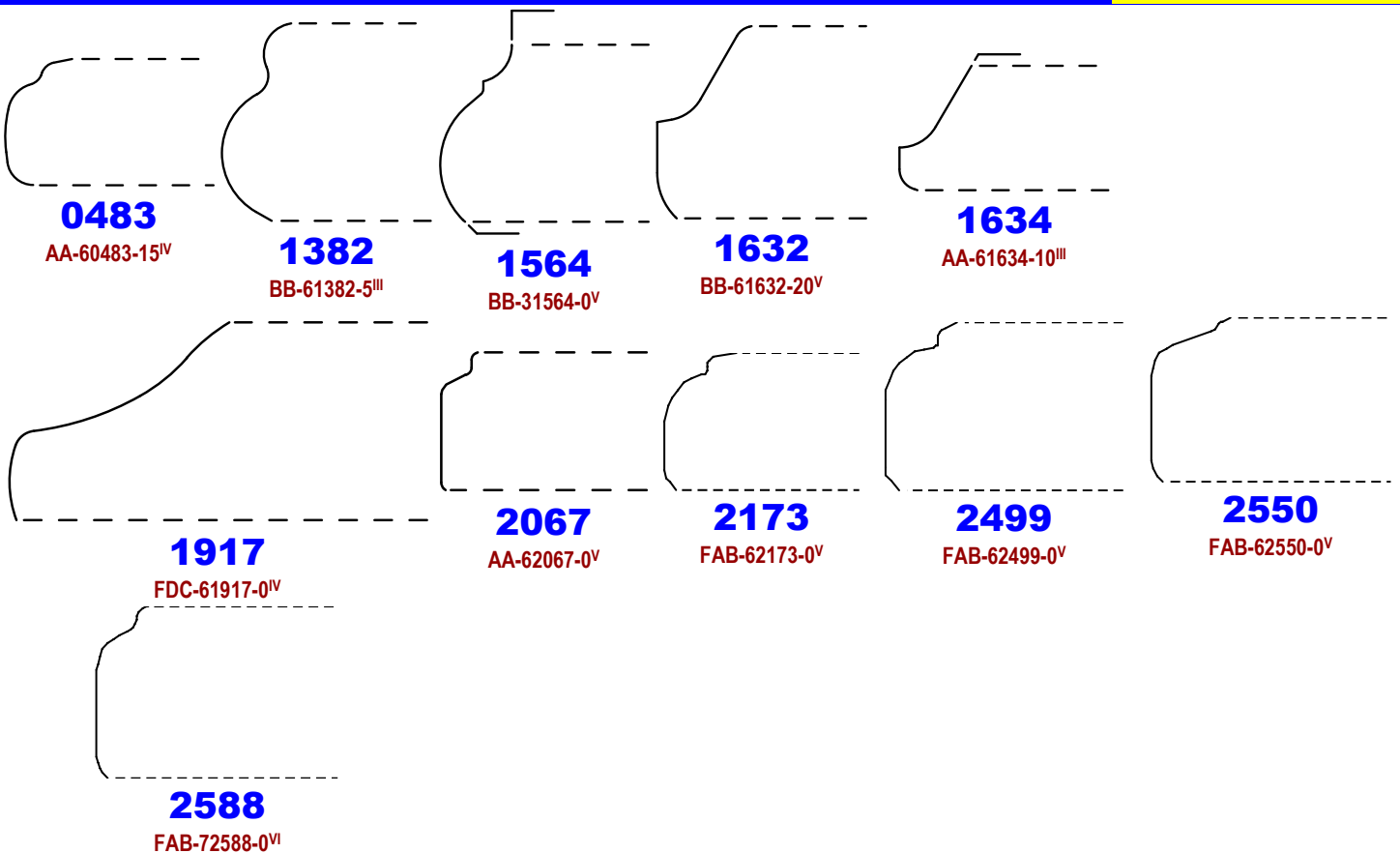

DOOR/DRAWER PULL

4-Curve with Convex Pull

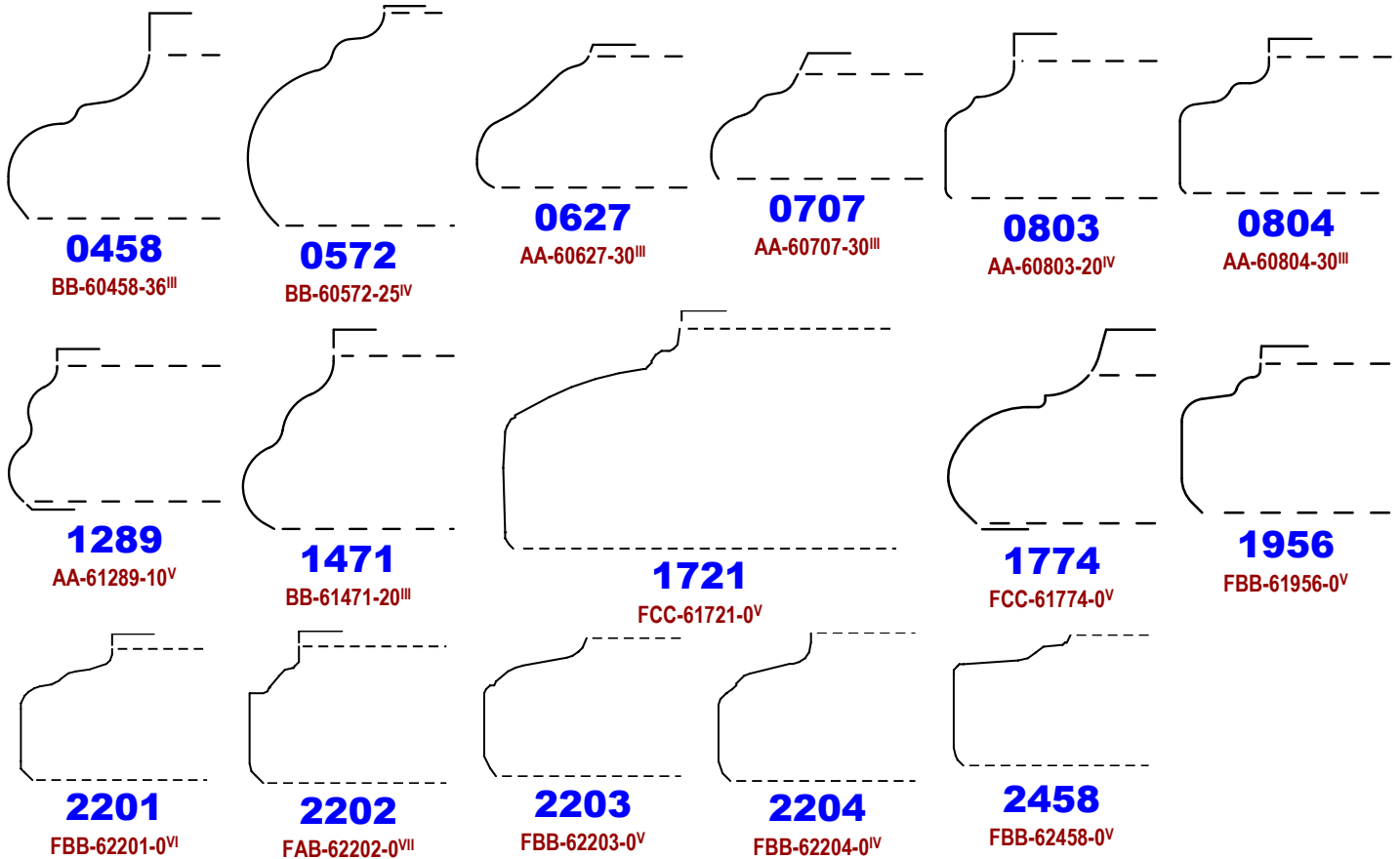

DOOR/DRAWER PULL

5-Curve wit Convex Pull

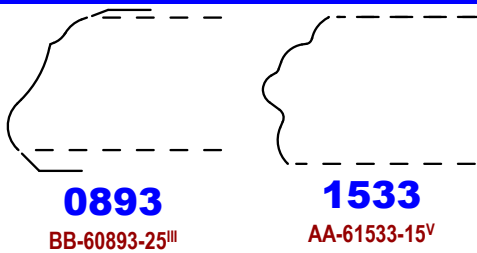

DOOR/DRAWER PULL

6-Curve wit Convex Pull

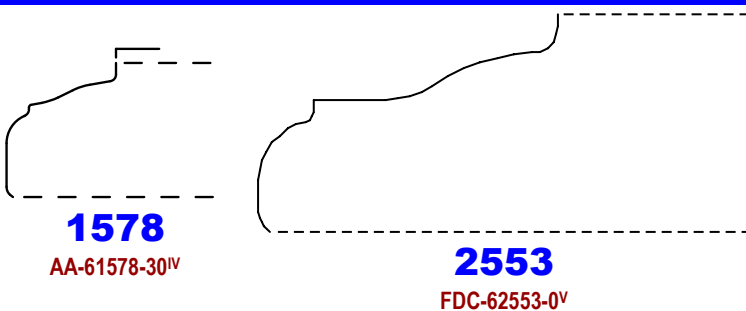

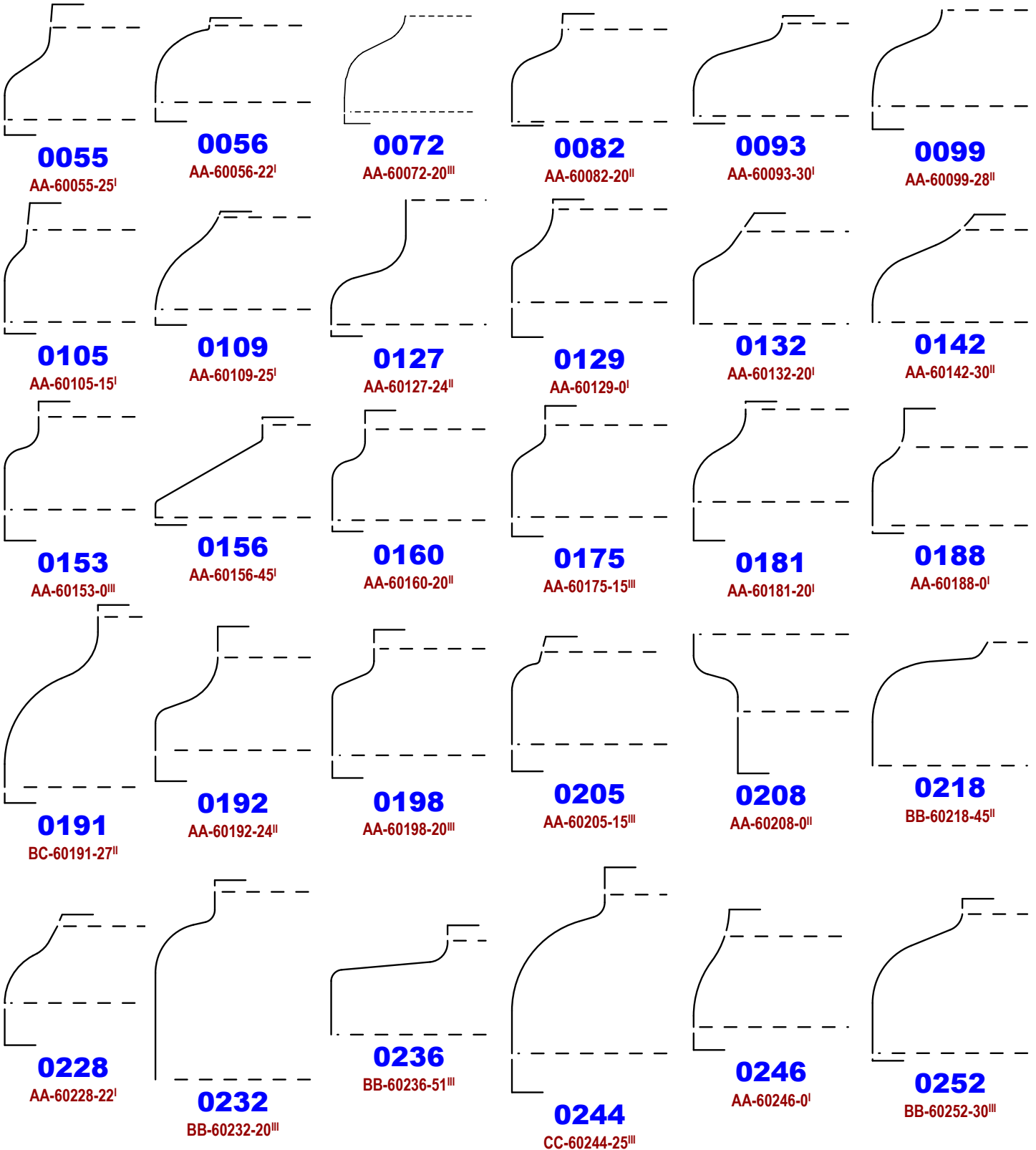

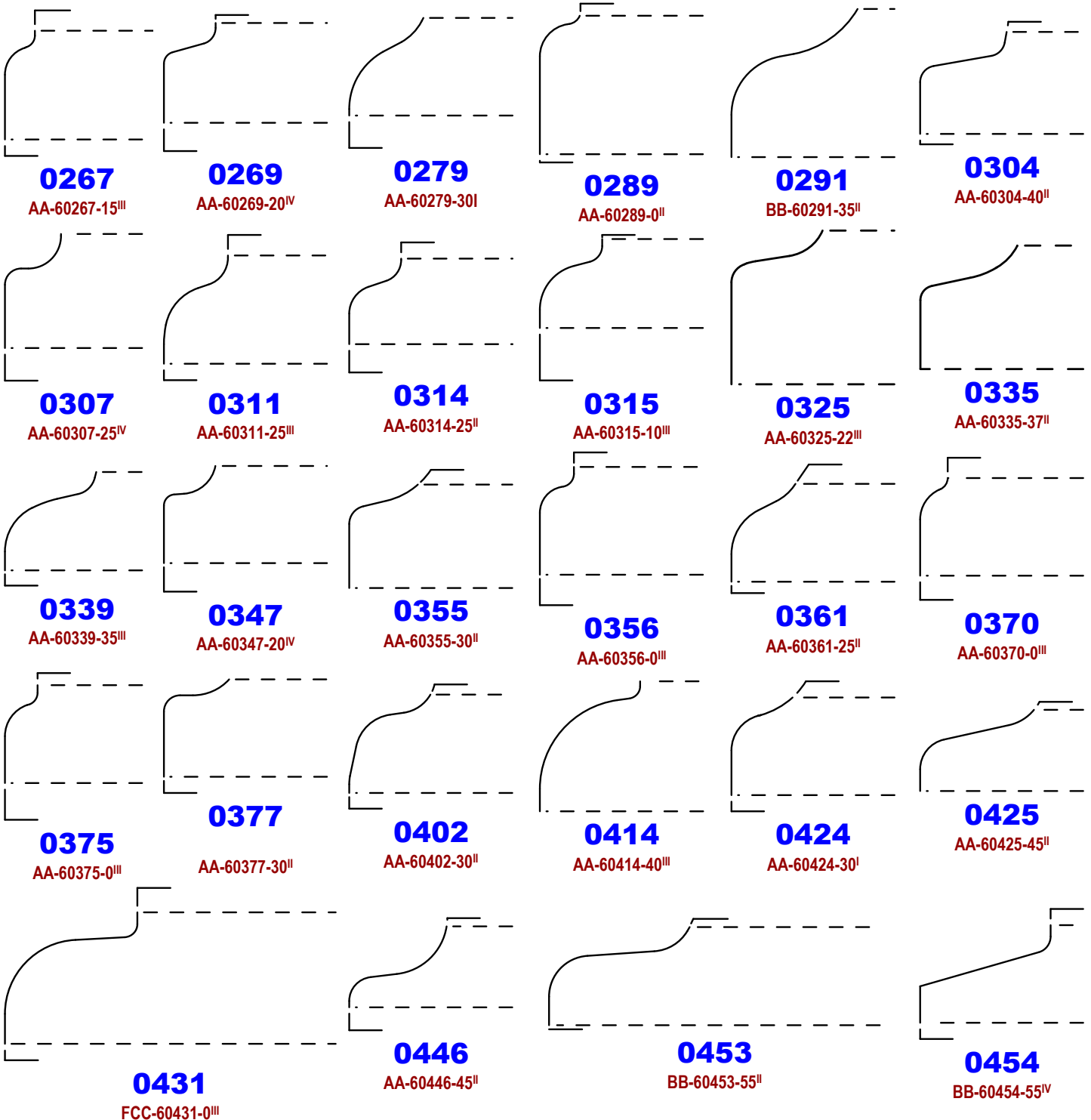

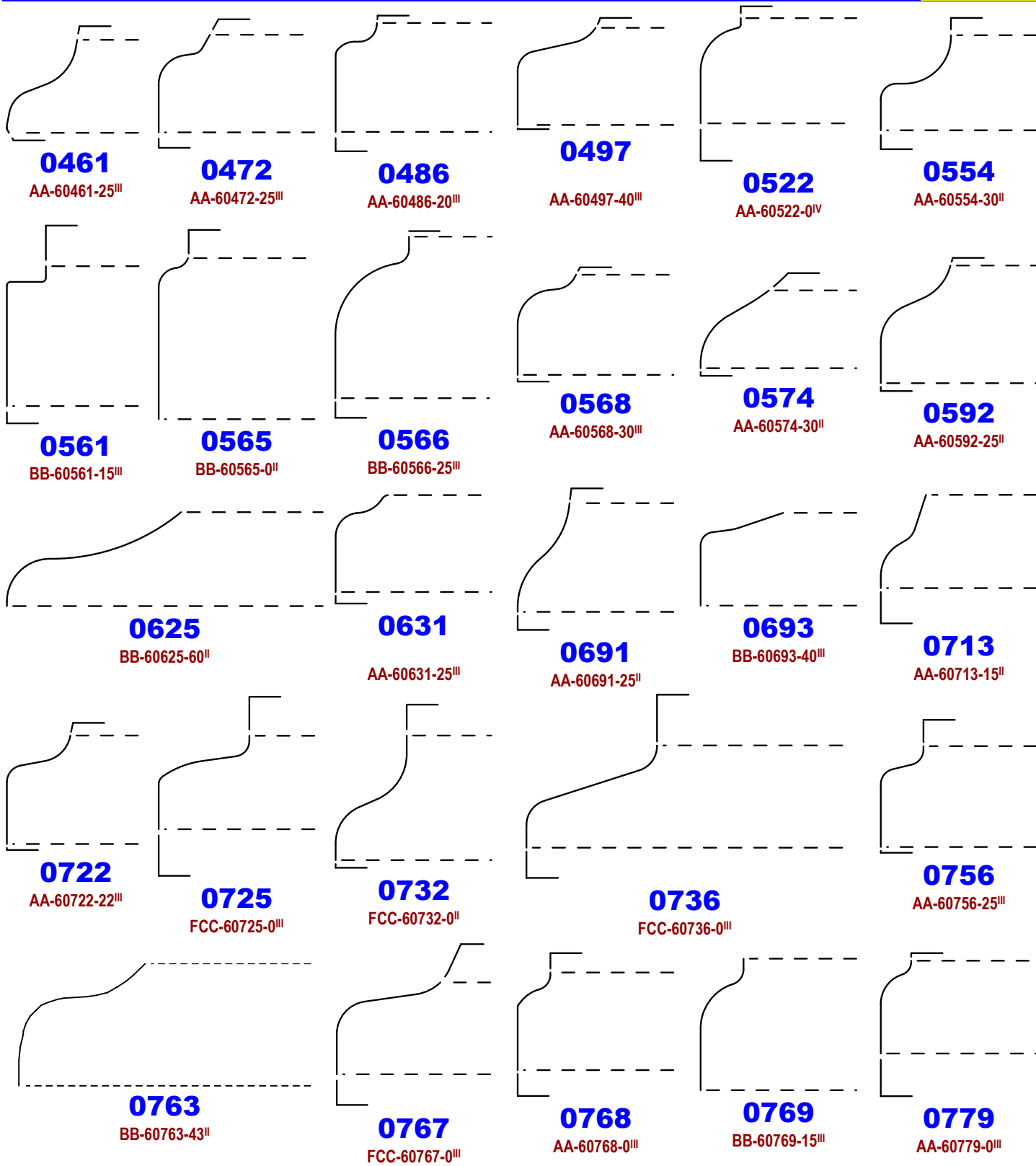

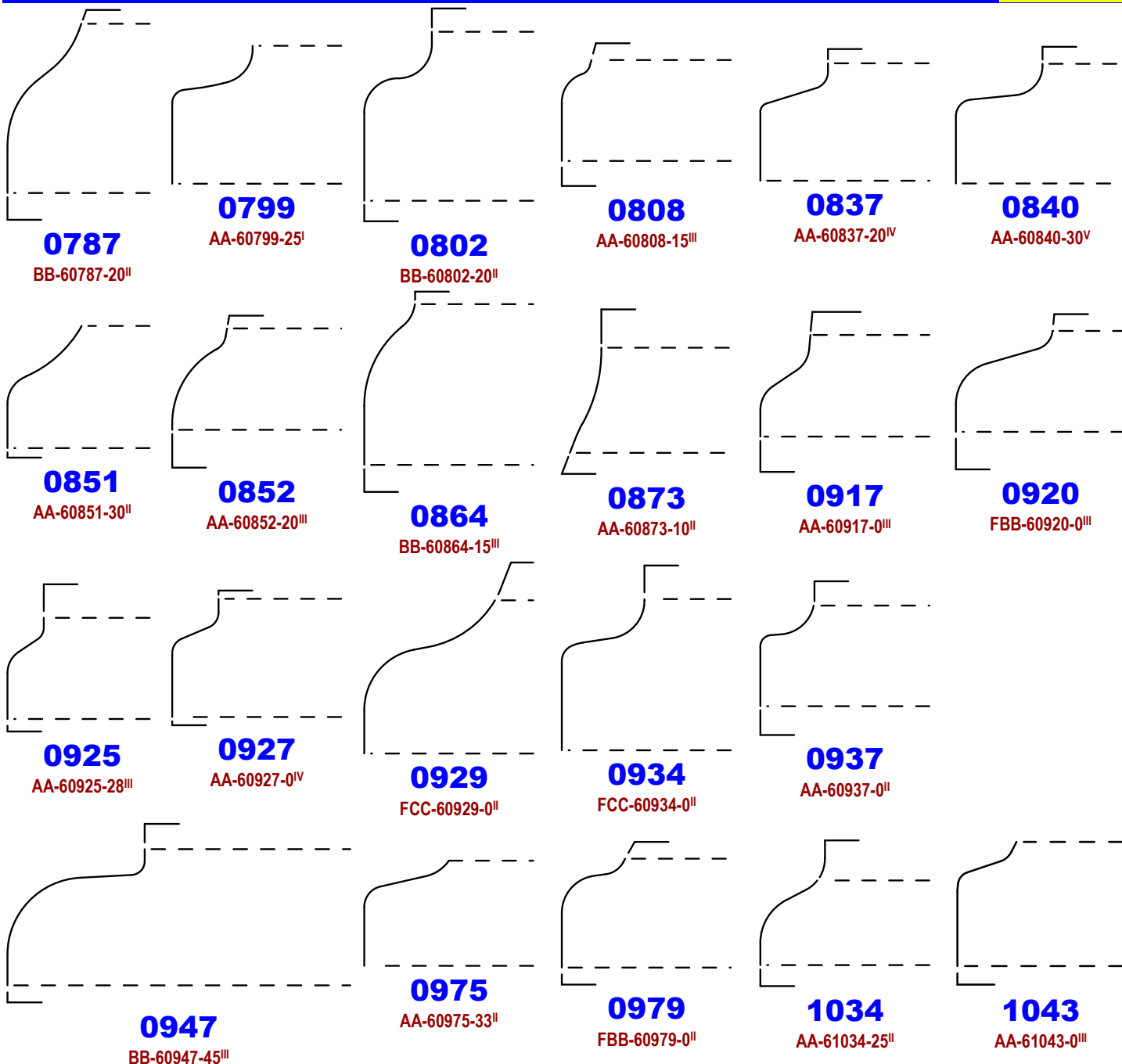

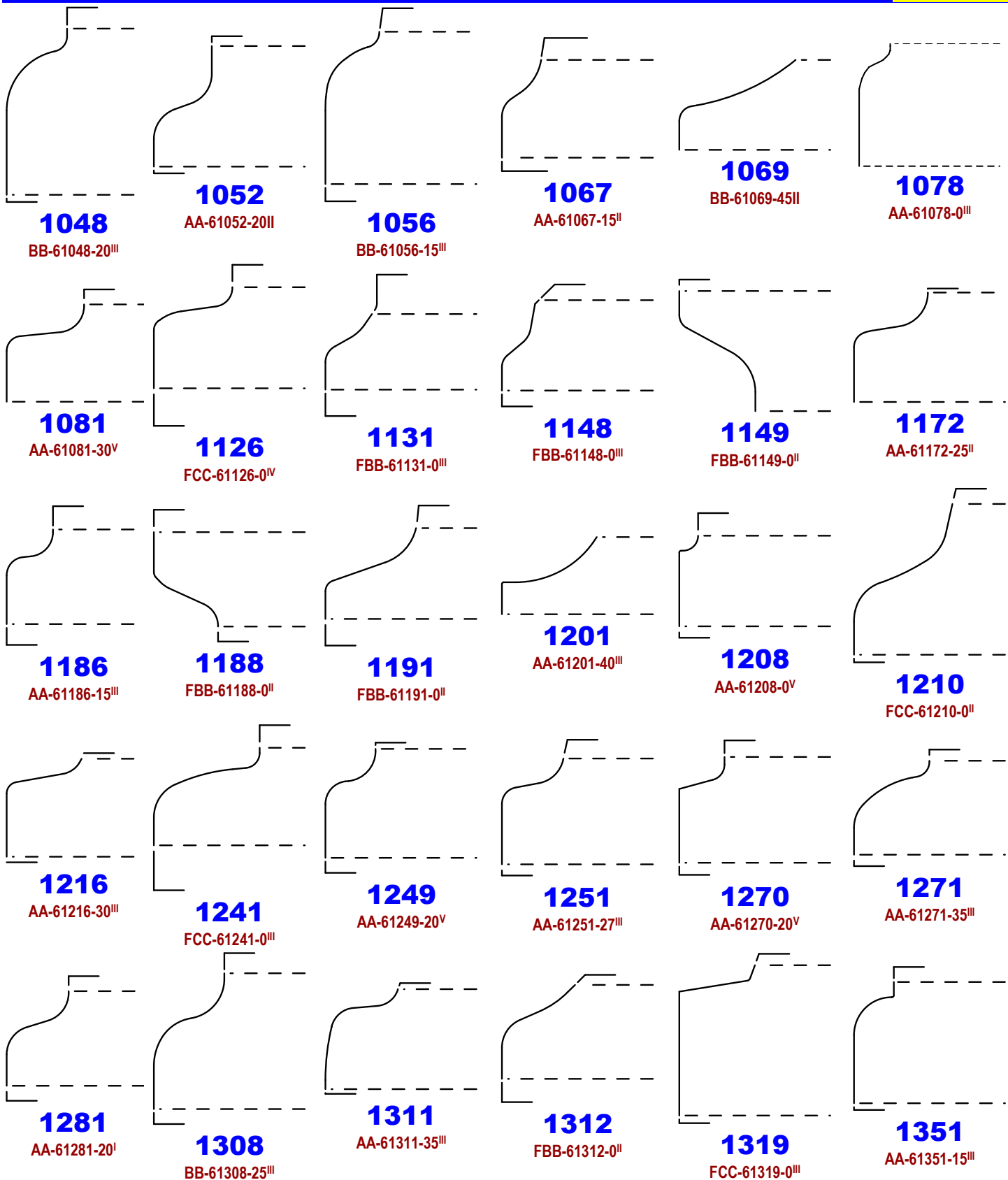

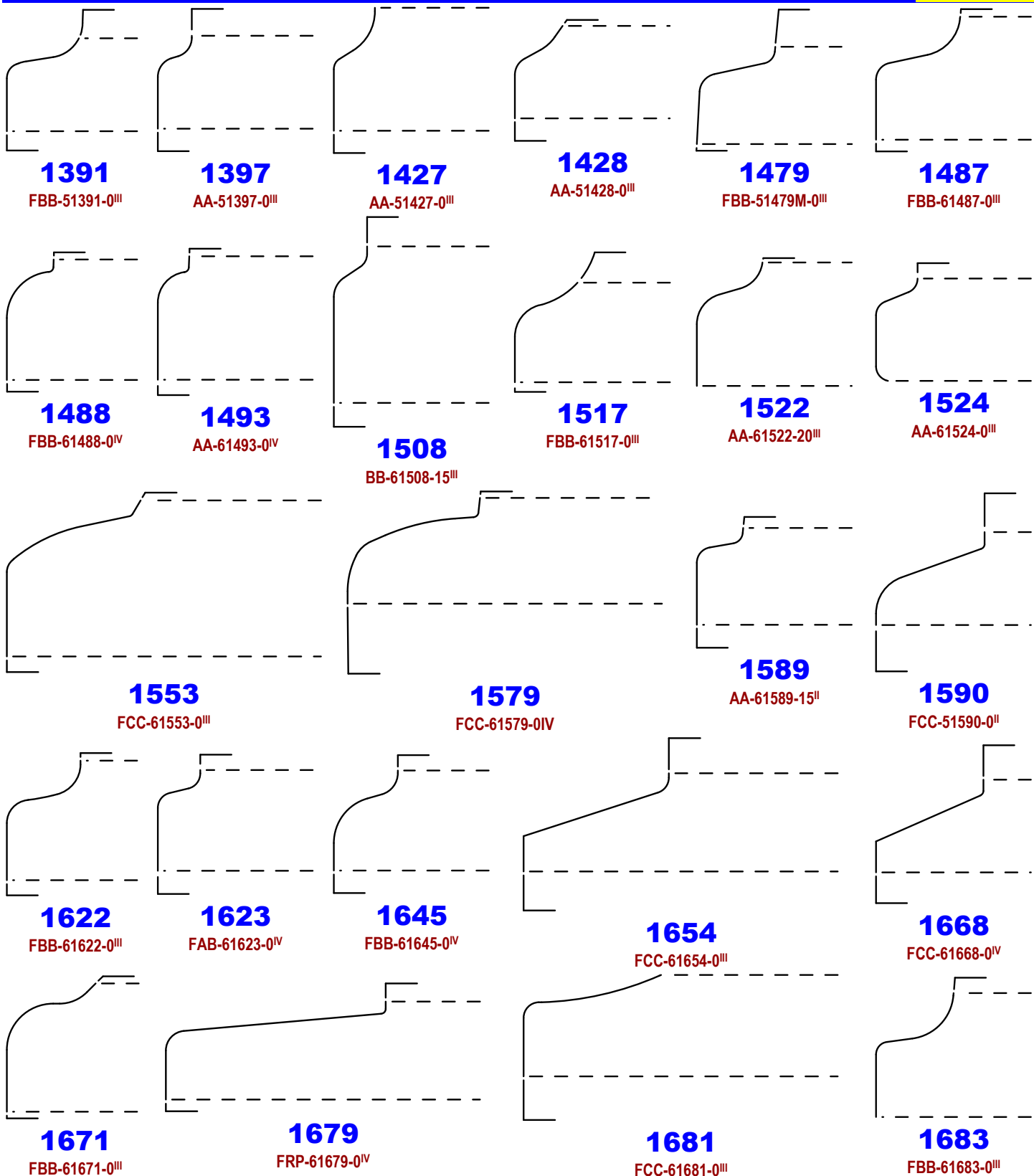

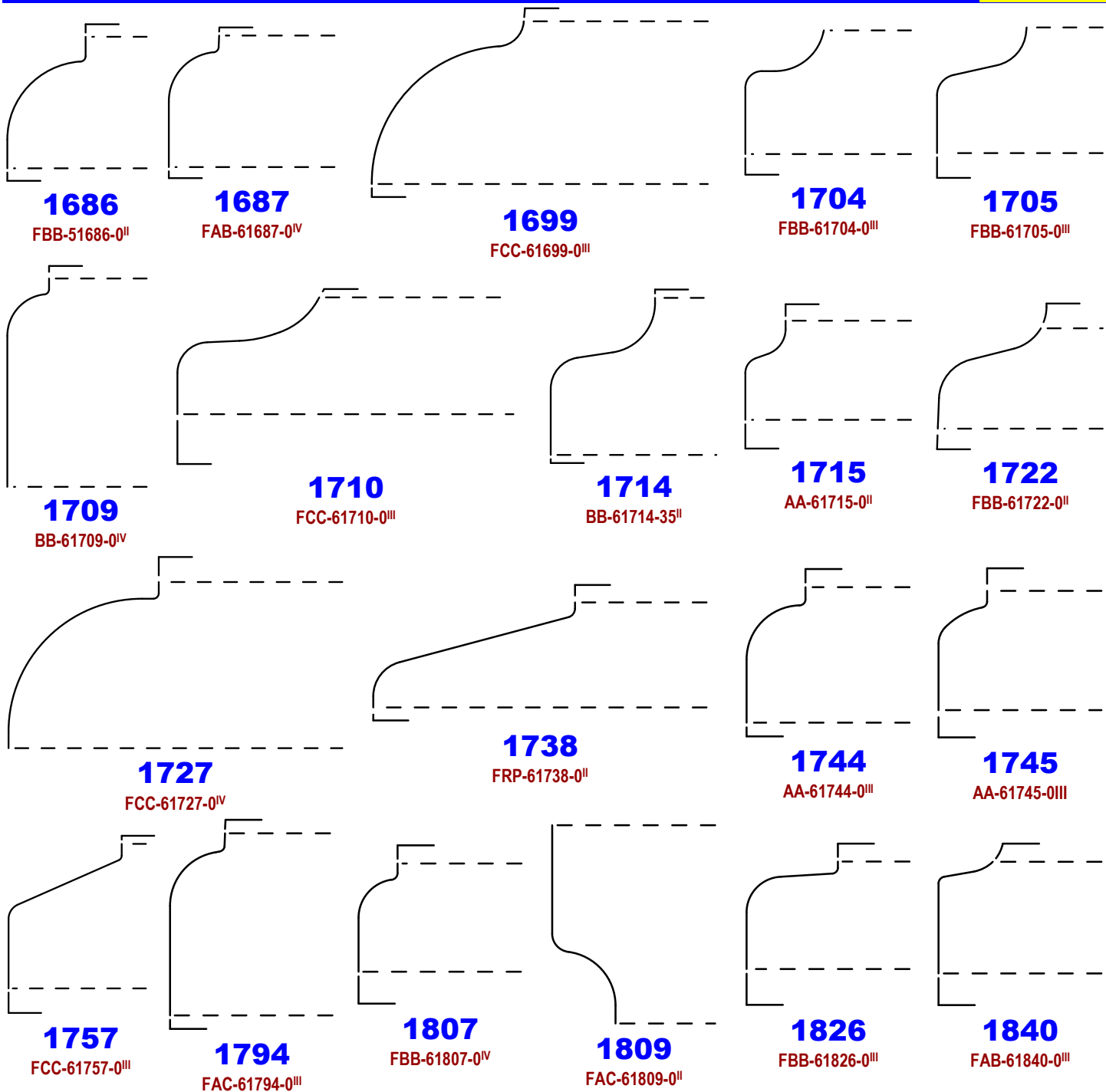

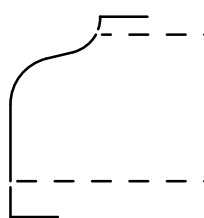

1841

FAB-61841-0^{II}

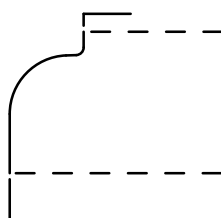

1860

AA-61860-0^{IV}

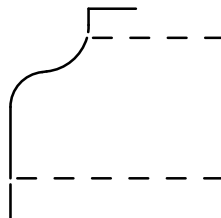

1866

AA-61866-0^{III}

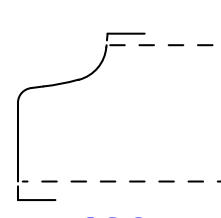

1867

FBB-61867-0^{II}

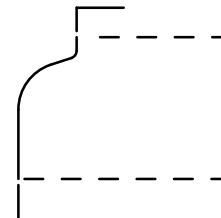

1878

AA-61878-0^{IV}

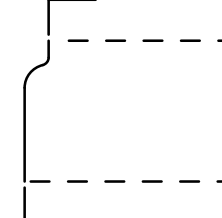

1882

AA-51882-0^{IV}

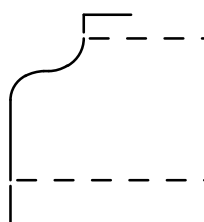

1884

AA-61884-0^{II}

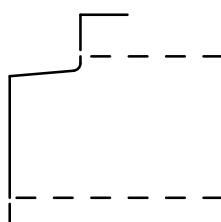

1889

AA-51889-0^{IV}

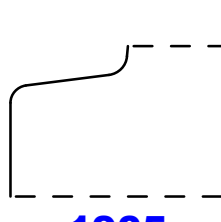

1905

AA-61905-35^{II}

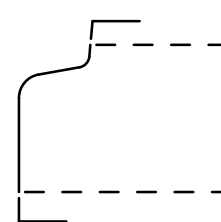

1919

AA-61919-0^{III}

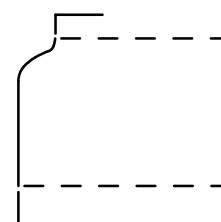

1963

AA-61963-0^{III}

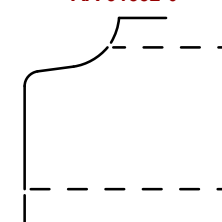

1967

FBB-61967-0^{II}

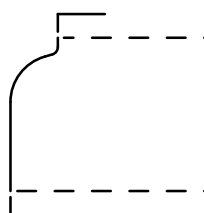

2000

FAB-62000-0^{III}

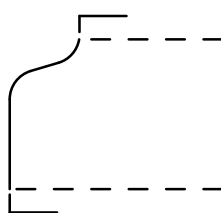

2004

AA-62004-0^{II}

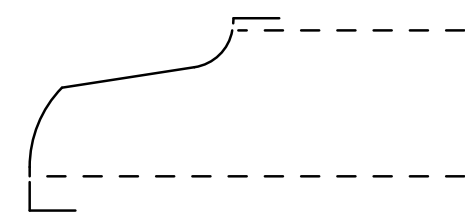

2005

FCB-62005-0^{III}

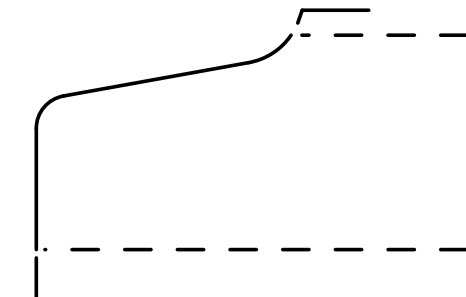

2006

FCB-62006-0^{II}

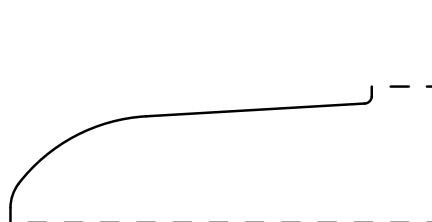

2009

FRP-62009-0^{IV}

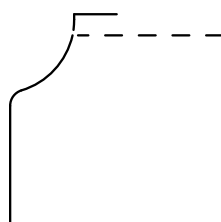

2042

BB-62042-0^{II}

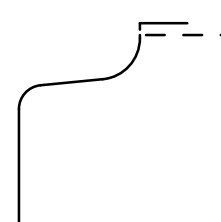

2055

FBC-62055-0^{II}

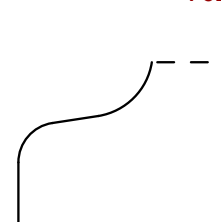

2058

FBB-52058-0^{II}

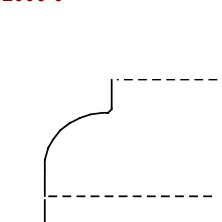

2124

FAB-62124-0^{II}

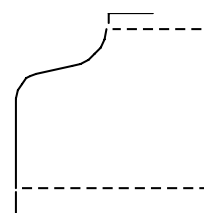

2155

FAB-62155-0^{II}

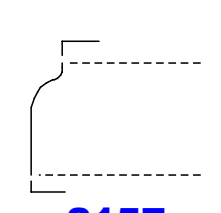

2157

AA-32157-0^{IV}

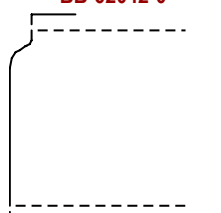

2160

AA-62160-0^{III}

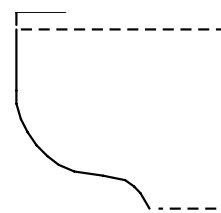

2167

FBB-62167-0^{II}

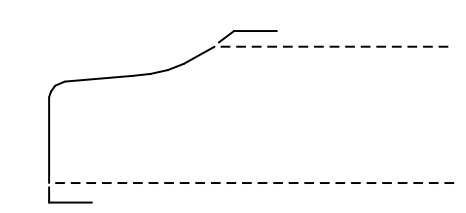

2185

FCB-62185-0^{II}

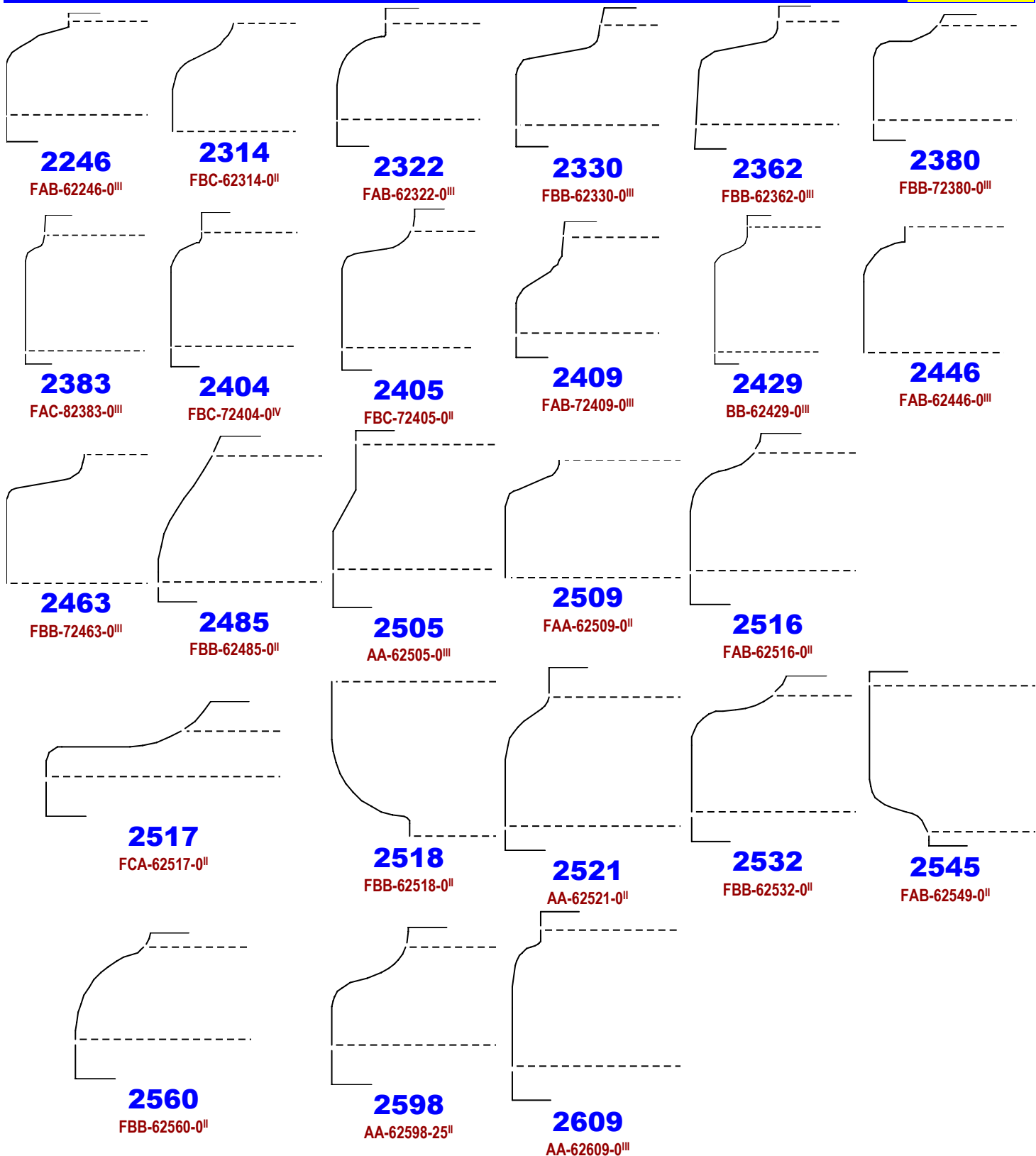

0161

AA-60161-90^{III}

0171

AA-60171-90^{III}

0172

AA-60172-90^{III}

0265

AA-60265-90^{III}

0366

AA-60366-80^{III}

0545

CC-60545-90^{III}

0720

AA-60720-90^{III}

0741

AA-60741-90^V

0743

AA-60743-90^V

0771

AA-60771-90^{III}

0772

AA-60772-90^{III}

0776

AA-60776-90^V

0785

AA-60785-90^{IV}

1041

AA-61041-90^{III}

1224

BB-61224-90^{III}

1226

AA-61226-90^{II}

1228

AA-61228-90^v

1230

BB-61230-90ⁱⁱⁱ

1232

AA-61232-90ⁱⁱⁱ

1260

AA-61260-90
ⁱⁱⁱ

1267

AA-61267-90
ⁱⁱⁱ

1272

AA-61272-90
^v

1467

BB-61467-90ⁱⁱⁱ

1924

RZ-21924-0^{vi}

2054

BB-62054-90^{iv}

2087

AA-62087-90ⁱⁱ

2104

AA-62104-90^{iv}

2396

AA-02396-90^{iv}

2492

AA-62492-90^v

2498

BB-62498-90^{iv}

2508

RZ-22508-0

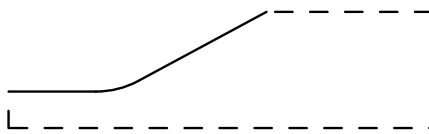

0322
RP-60322-0^I

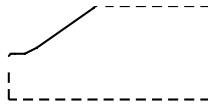

1144
FBB-61144-0^{II}



1369
RP-61369-0^{IV}

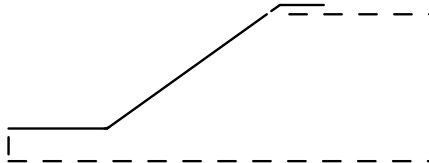

1393
RP-61393-0^{IV}

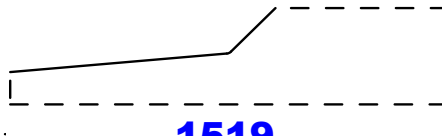

1519
RP-61519-12^{III}

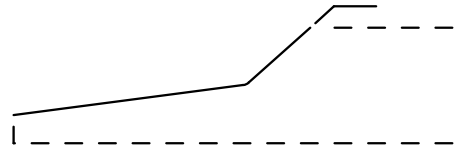

1717
FRP-61717-0^{IV}

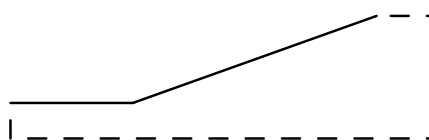

1817
RP-61817-0^{III}

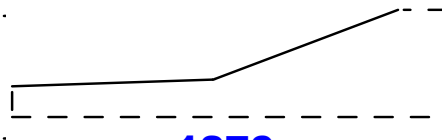

1870
FRP-61870-0^{II}

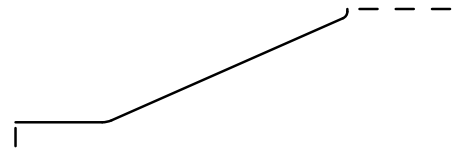

1921
RP-61921-0^{III}



1997
RP-61997-0^{II}

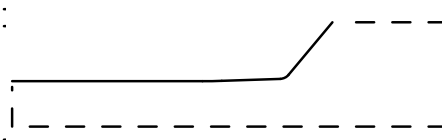

2021
RP-62021-0^{III}

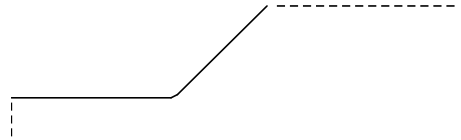

2103
RP-82103-12^{III}

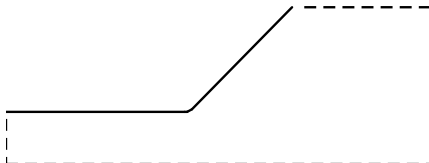

2165
RP-62165-0^{III}

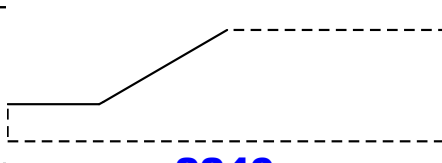

2240
RP-62240-0^{III}

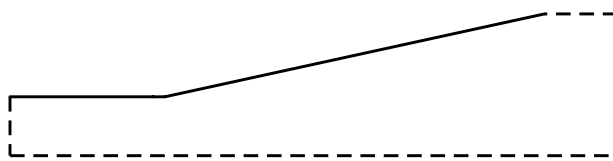

2368
F1RP-62368-0^I

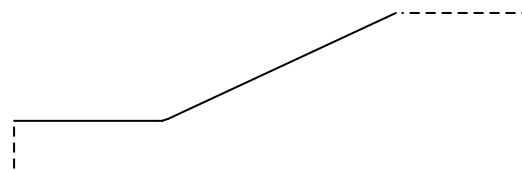

2512
RP-82512-0^{III}



2583
RP-62583-0^{III}

RAISED PANEL

Simple Scoop

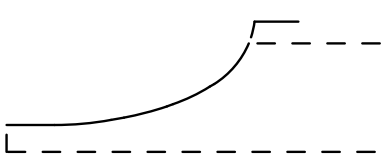

0097
RP-60097-0'

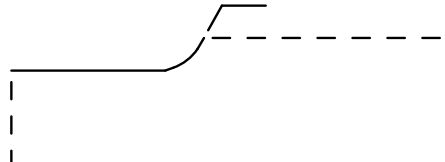

0213
RP-60213-5''

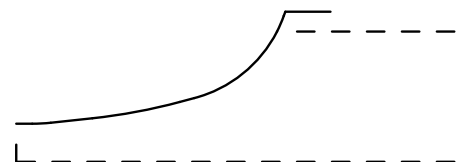

0259
RP-60259-0''

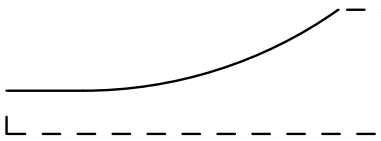

0274
RP-60274-0'



0286
RP-60286-0'

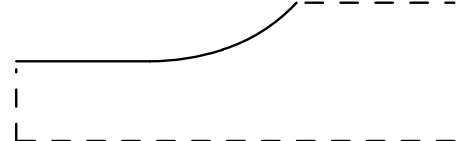

0305
RP-60305-0''

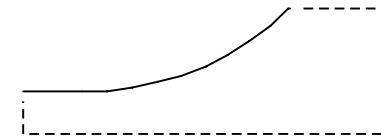

0308
RP-60308-0''

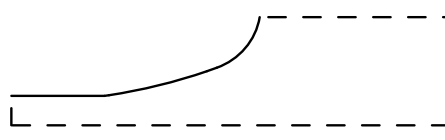

0334
RP-60334-0''

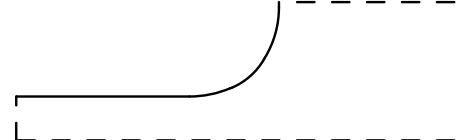

0341
RP-60341-0''

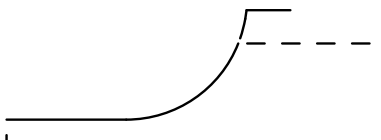

0348
RP-60348-0''



0349
RP-60349-0''

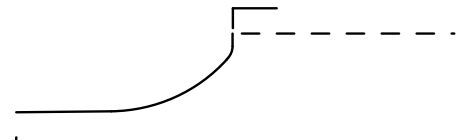

0351
RP-60351-0''

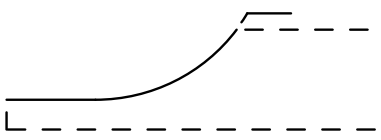

0367
RP-60367-0''



0373
RP-60373-0''

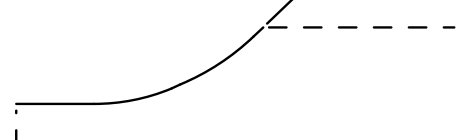

0410
RP-60410-0''



0411
RP-60411-0'

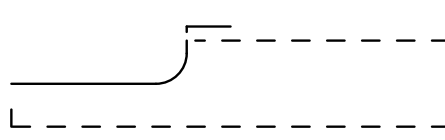

0426
AA-60426-75''

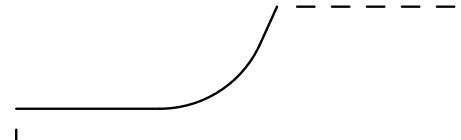

0427
RP-60427-0''

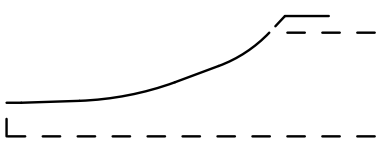

0433
RP-60433-0"

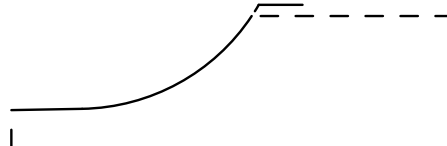

0451
RP-60451-0"

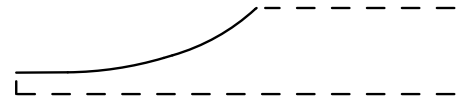

0460
RP-60460-0"

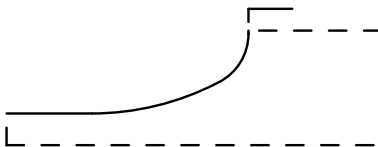

0465
RP-60465-0"

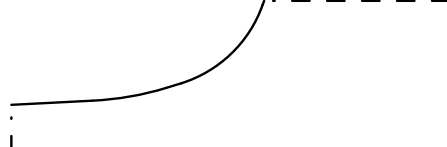

0484
RP-60484-0"

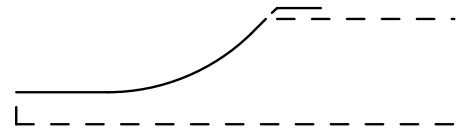

0487
RP-60487-0"

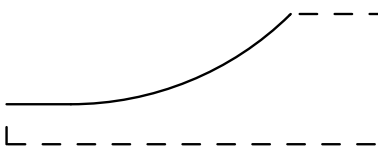

0493
RP-60493-0"

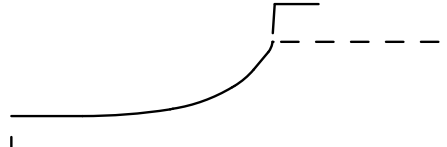

0516
RP-60516-0"

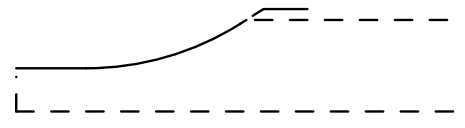

0530
RP-60530-0"



0564
RP-60564-0"

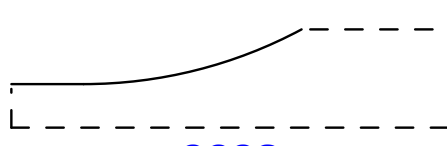

0603
RP-60603-0"

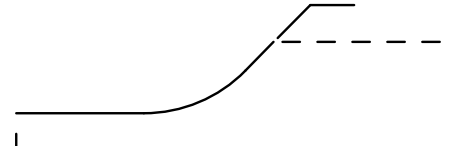

0640
BB-60640-70"

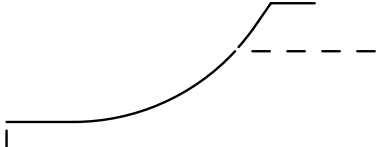

0641
BB-60641-70"

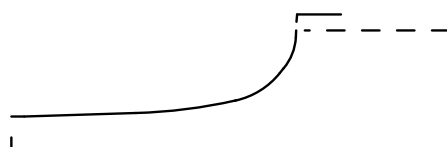

0782
RP-60782-0"

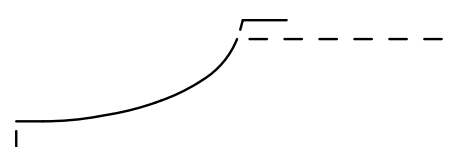

0921
RP-60921-12"



0922
BB-60922-65"

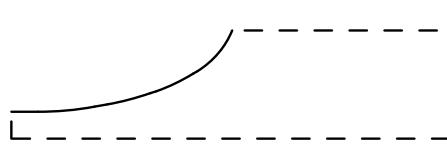

0923
RP-60923-8"



0930
RP-60930-12"

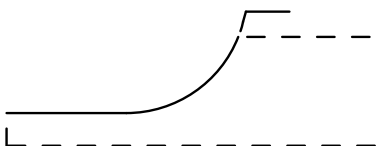

0939
RP-60939-12"

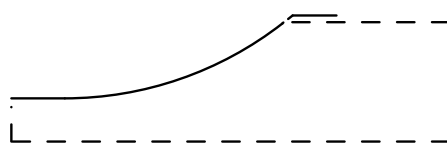

0940
RP-60940-12"

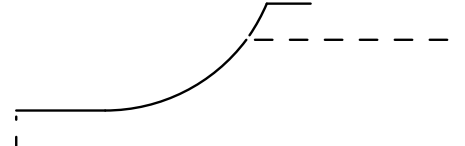

0944
RP-60944-12"

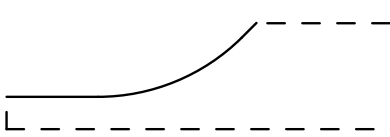

0946
RP-60946-12"

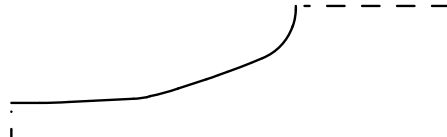

1174
RP-61174-0"

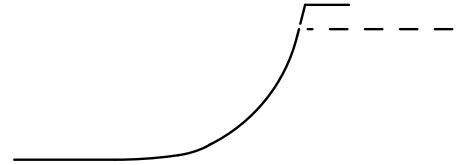

1187
RP-61187-0"

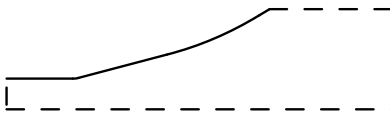

1248
RP-61248-12"

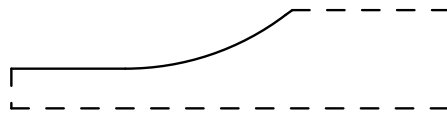

1288
RP-61288-12"



1387
RP-51387-0"

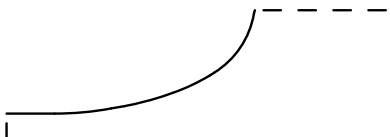

1410
RP-51410-0"



1435
RP-51435-0"

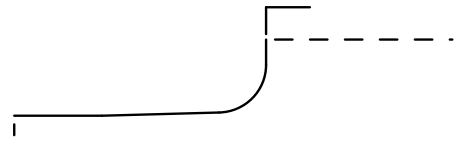

1497
RP-61497-0"

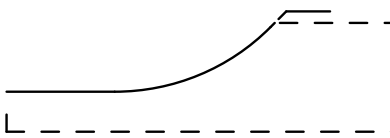

1554
RP-61554-12"

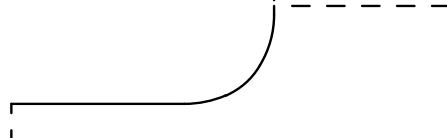

1608
RP-61608-0"

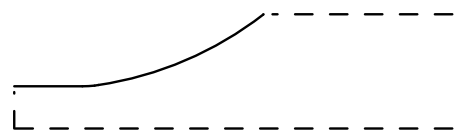

1609
RP-61609-0"

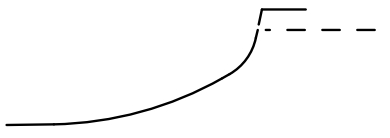

1630
RP-61630-12"

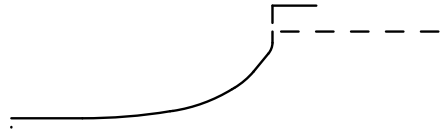

1638
RP-61638-0"



1655
RP-61655-12"

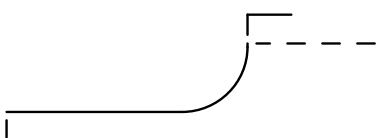

1660
RP-51660-0"



1661
RP-51661-0"

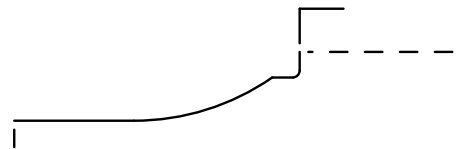

1665
RP-61665-0"

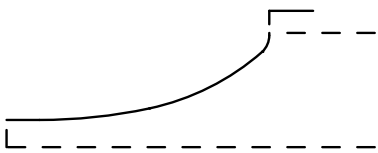

1667

RP-61667-0^{II}

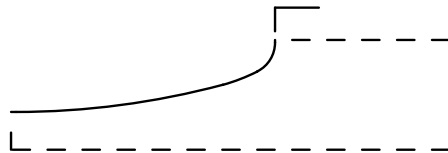

1685

RP-61685-0^{II}

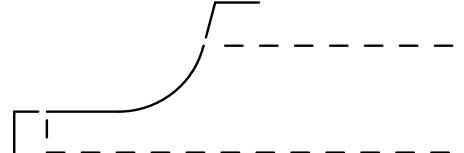

1701

AA-61701-60^{II}

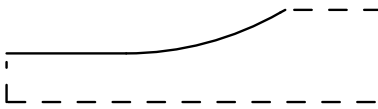

1702

BB-61702-75^{II}



1728

RP-61728-0^{II}



1741

RP-61741-0^{II}

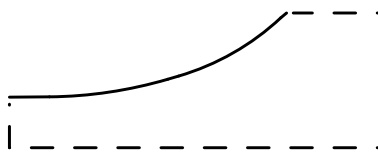

1776

RP-51776-0^{III}

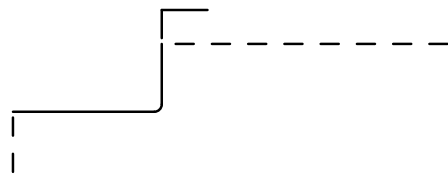

1811

RP-51811-0^{III}

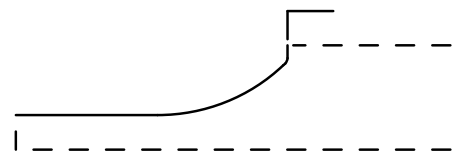

1823

RP-61823-0^{III}

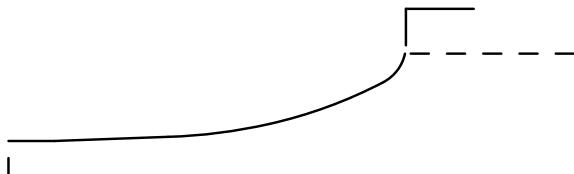

1831

FRP-61831-0^{II}

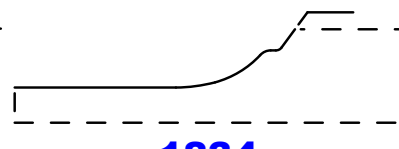

1834

RP-61834-0^{IV}

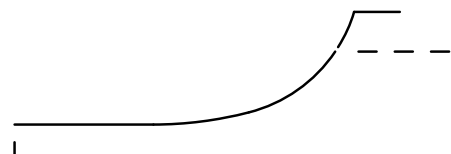

1835

RP-61835-0^{II}

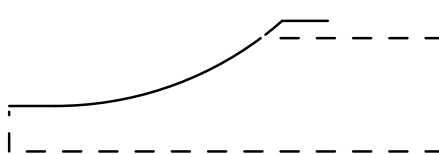

1839

RP-61839-0^{II}



1940

F1RP-61940-0^{III}



1978

RP-61978-0^{III}



1988

RP-61988-12^{II}

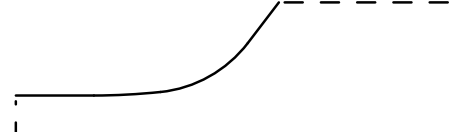

2039

RP-62039-0^{II}

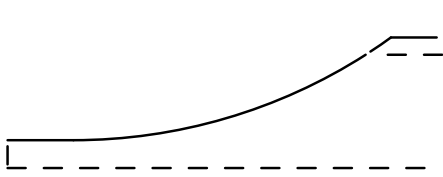

2041
F1RP-62041-0^{II}

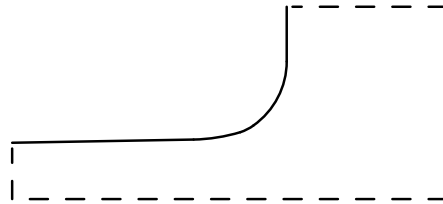

2043
RP-62043-0^{II}

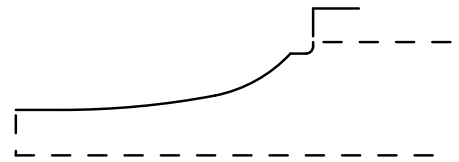

2065
RP-62065-0^{III}

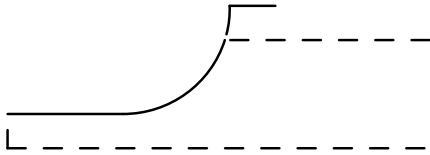

2082
RP-62082-0^{II}

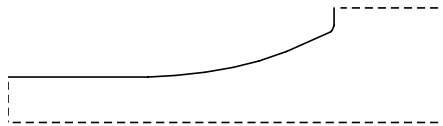

2101
F2RP-62101-12^{III}

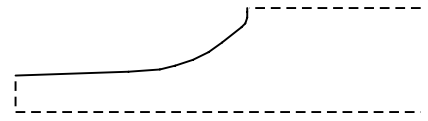

2120
RP-62120-0^{II}

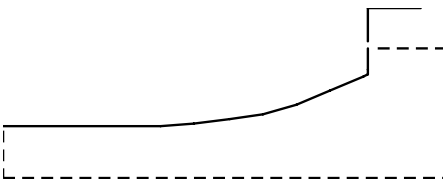

2164
RP-62164-0^{III}

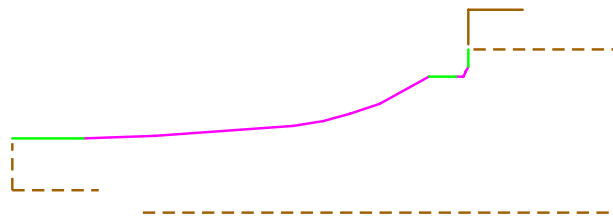

2168
RP-82168-0^{III}

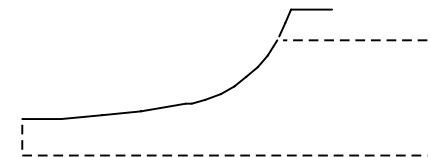

2170
F1RP-62170-0^{II}

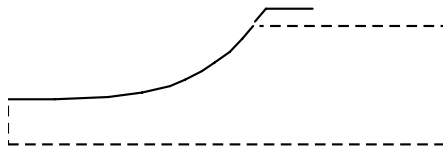

2260
RP-62260-12^{II}

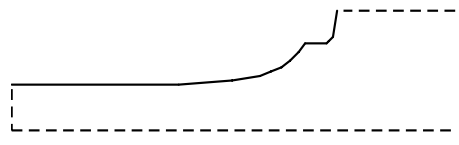

2262
RP-62262-12^{IV}

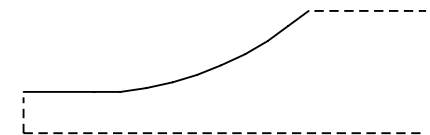

2310
RP-82310-0^{II}

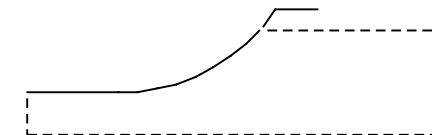

2450
RP-62450-0^{II}



2474
RP-62474-0^{II}



2537
RP-62537-0^{II}

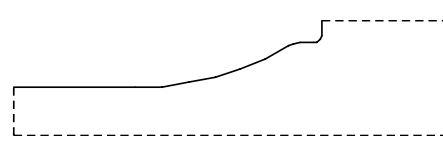

2544
RP-62544-0^{IV}

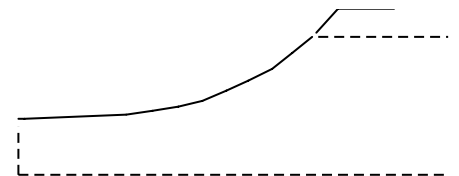

2549
RP-62549-0^{II}

RAISED PANEL

Simple Scoop

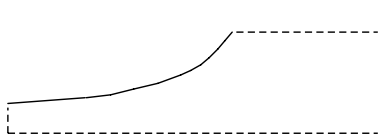

2584
RP-72584-0^{II}

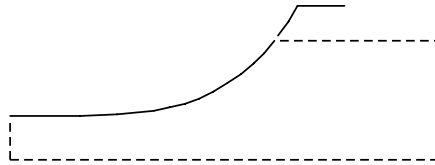

2601
RP-62601-0^{II}

RAISED PANEL

Bezel / Simple Lip

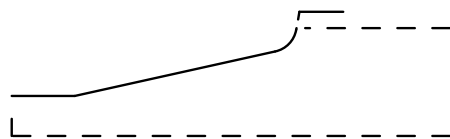

0235
RP-60235-5^{II}

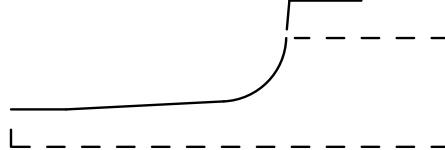

0254
RP-60254-0^{II}

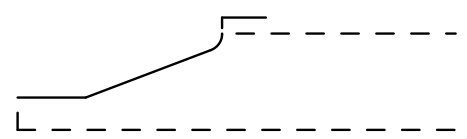

0268
RP-60268-0^{III}

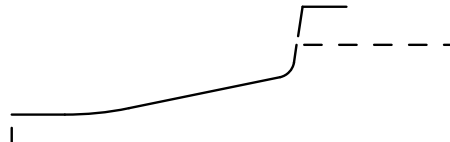

0294
RP-60294-0^{III}



0298
RP-60298-0^{III}

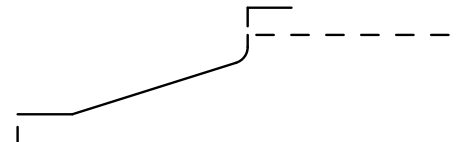

0299
RP-60299-0^{IV}

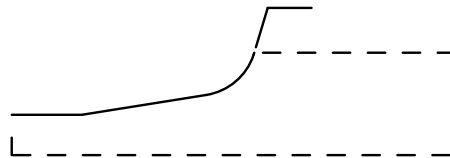

0327
RP-60327-0^{II}



0365
RP-60365-0^{II}

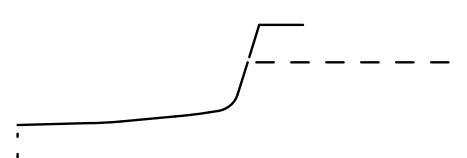

0378
RP-60378-0^{III}

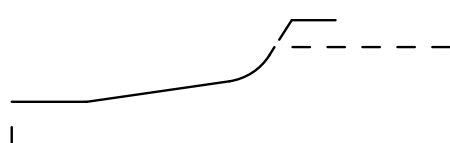

0393
RP-60393-0^{II}

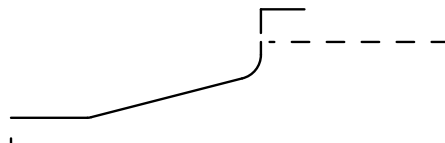

0418
RP-60418-0^{III}

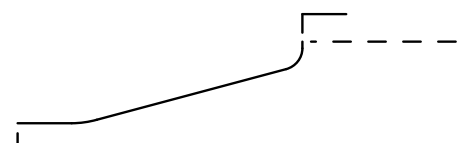

0455
RP-60455-0^I

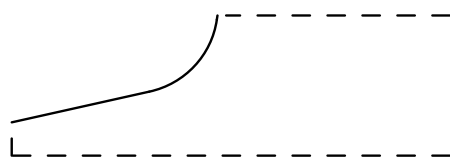

0471
RP-60471-0^{II}

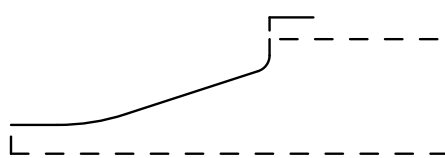

0481
RP-60481-0^{IV}

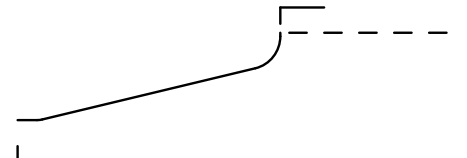

0507
RP-60507-0^{III}

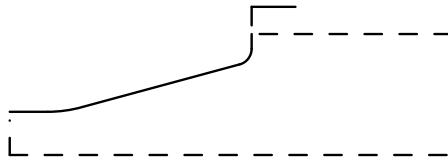

0559

RP-60559-0^{IV}

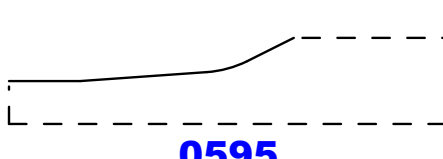

0595

RP-60595-0^{II}

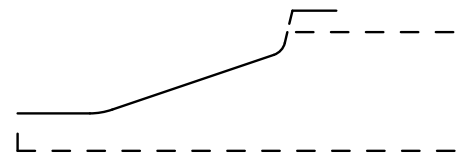

0616

RP-60616-0^{III}

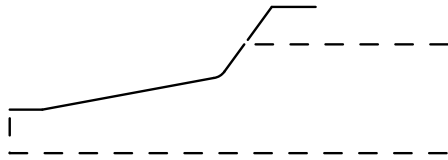

0617

RP-60617-0^{III}

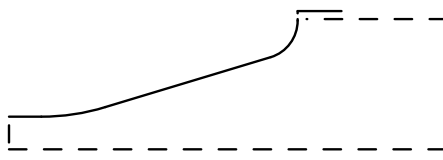

0668

RP-60668-0^{II}

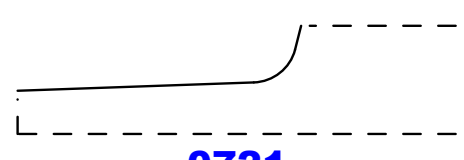

0721

RP-60721-0^{II}

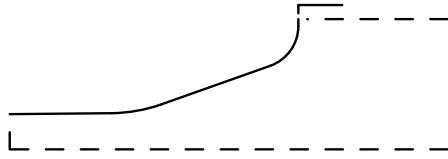

0789

RP-60789-0^I

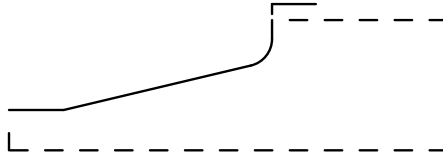

0806

RP-60806-0^I

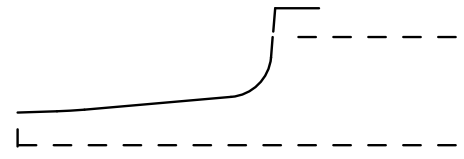

0888

RP-60888-0^I

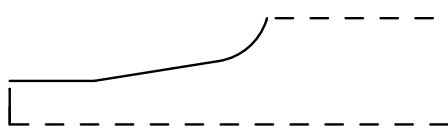

0935

RP-60935-12^{II}

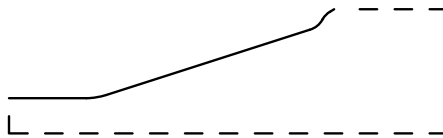

0998

RP-60998-0^{III}



1054

RP-61054-0^{II}

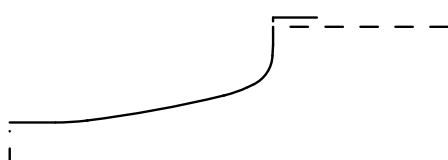

1108

RP-61108-0^{III}

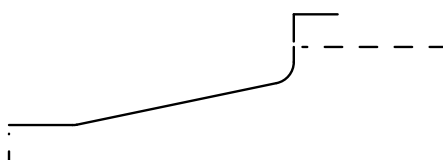

1291

RP-61291-0^{III}

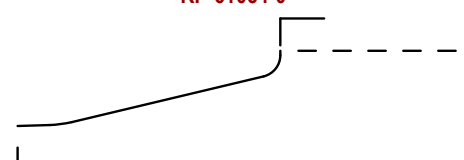

1300

RP-61300-0^{II}

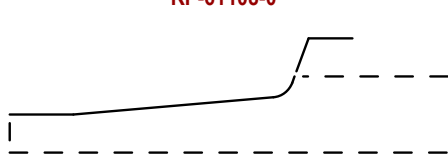

1333

RP-61333-0^{II}



1368

RP-61368-0^I

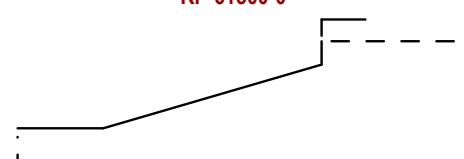

1442

RP-61442-0^{IV}

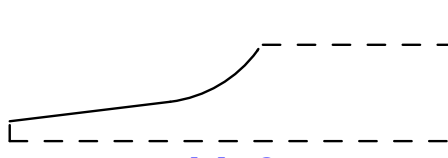

1470

RP-61470-0^I

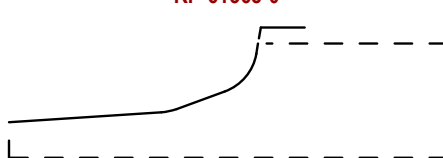

1472

RP-61472-0^{III}



1495

RP-61495-0^{IV}

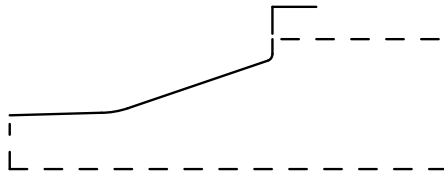

1499

RP-61499-0^{IV}

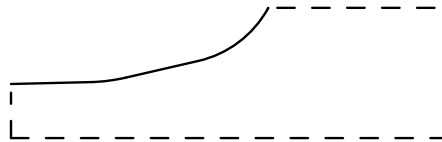

1500

RP-61500-0^{III}



1534

RP-61534-12^{III}

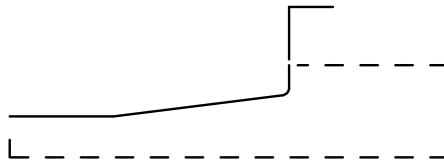

1559

RP-61559-0^{IV}

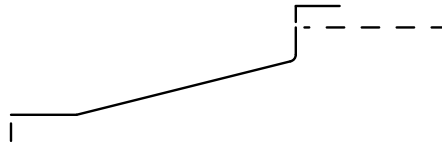

1560

RP-61560-0^{IV}

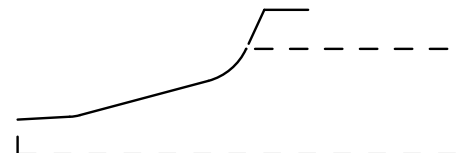

1576

RP-61576-0s

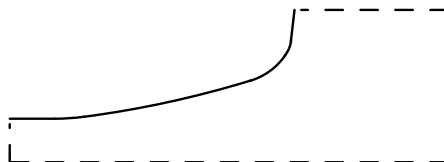

1592

RP-61592-0^{IV}

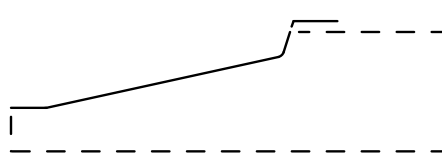

1602

RP-61602-0^{IV}

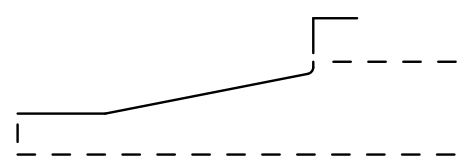

1614

RP-61614-0^{IV}

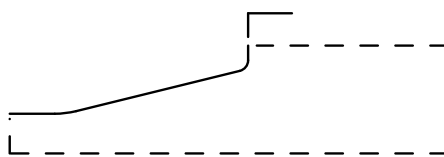

1625

RP-61625-0^V

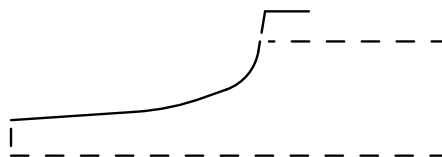

1640

RP-61640-0^{III}

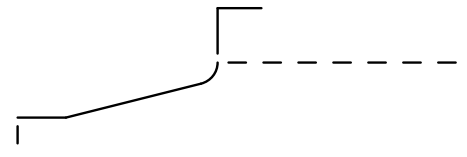

1641

RP-61641-0^{III}

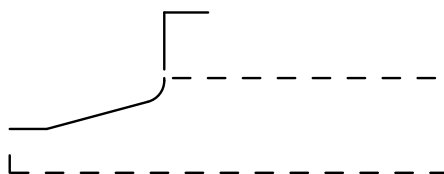

1652

AA-61652-50^{II}

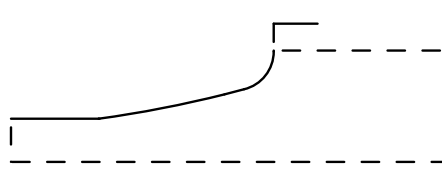

1663

RP-51663-0^{II}

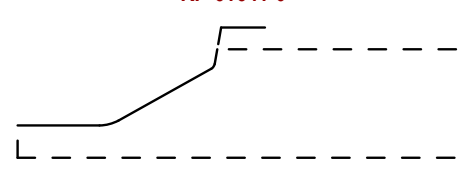

1689

RP-51689-0^{IV}

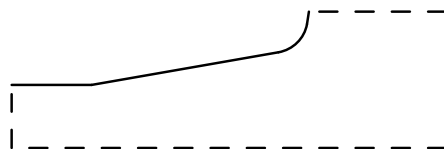

1718

RP-61718-0^{II}

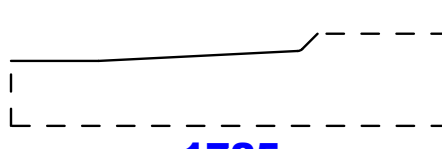

1725

RP-61725-0^{IV}

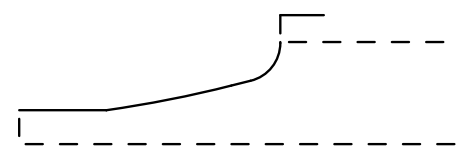

1730

RP-61730-0^{II}

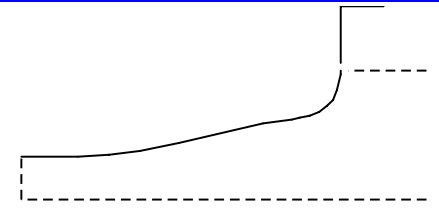

1740

FRP-61740-0^{II}

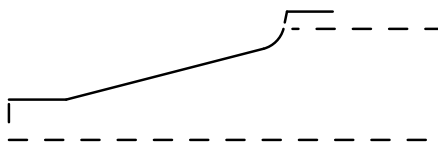

1753

RP-61753-12^{III}

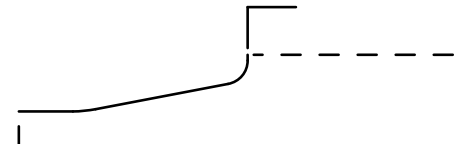

1775

RP-61775-0^{II}

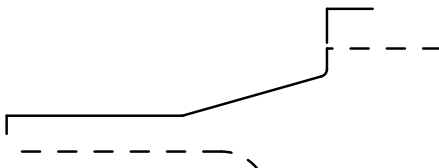

1814

RP-61814-0^{III}

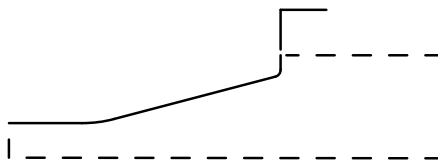

1822

RP-61822-0^{IV}

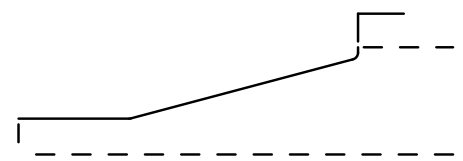

1836

RP-61836-0^{III}



1872

FIRP-61872-0^{II}

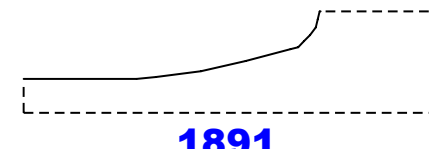

1891

RP-61891-0^{II}

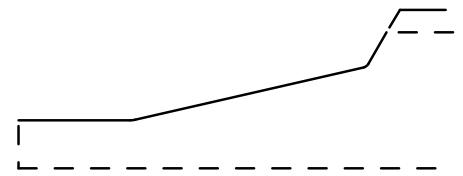

1916

FRP-61916-0^{III}

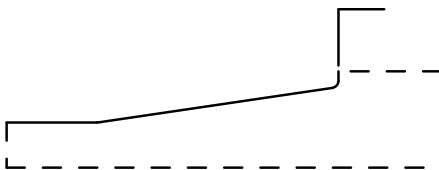

1920

RP-61920-0^{II}

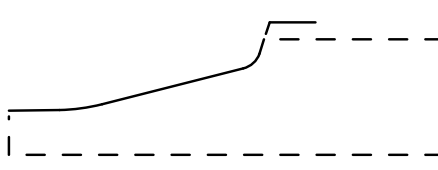

1923

RP-61923-0^{II}

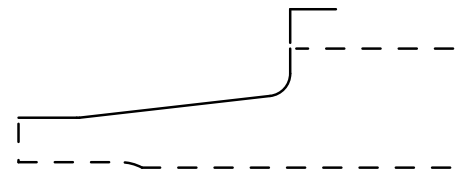

1931

RP-61931-0^{II}

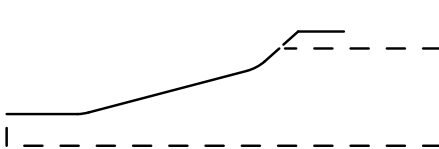

1944

RP-61944-0^{II}

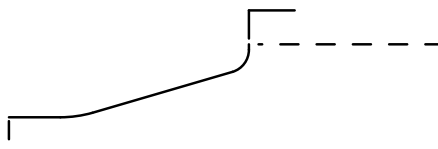

1950

RP-61950-0^{II}

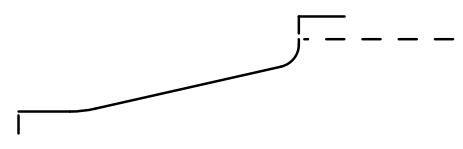

1951

RP-51951-0^{II}

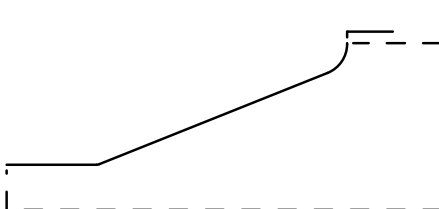

1975

RP-61975-0^{III}

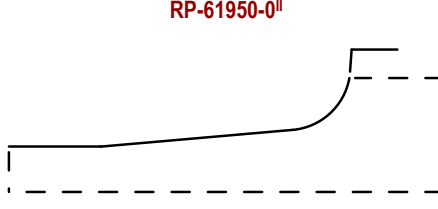

1976

RP-61976-0^{III}

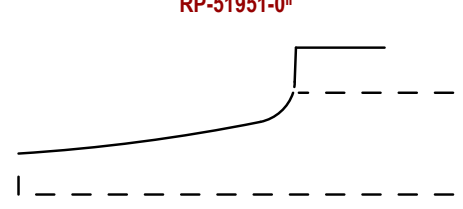

2007

RP-62007-0^{III}

RAISED PANEL

Bezel / Simple Lip

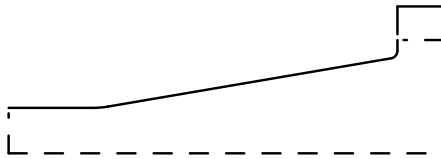

2016
F1RP-62016-0^{III}

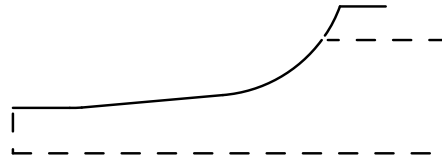

2017
F1RP-62017-0^{III}

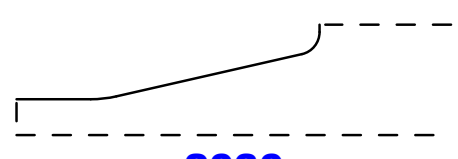

2030
RP-62030-0^{III}

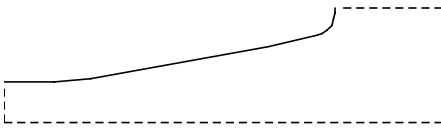

2119
F1RP-62119-0^{III}

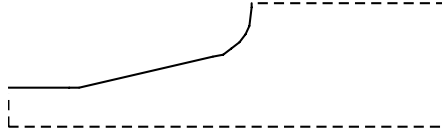

2137
RP-62137-0^{III}

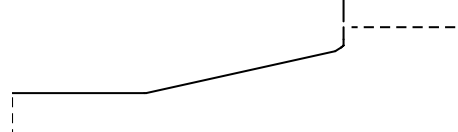

2162
RP-62162-0^{IV}

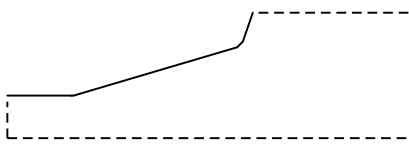

2231
RP-62231-0^V



2261
RP-62261-12^{III}

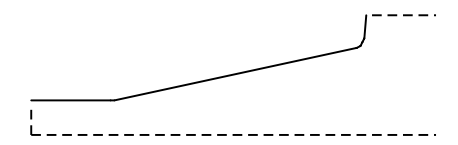

2382
RP-82382-0^{IV}

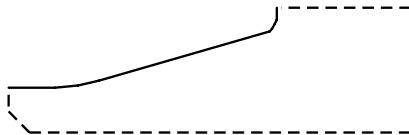

2424
RP-62424-0^{III}

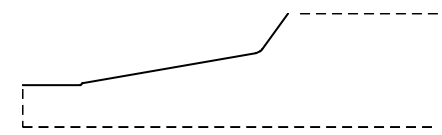

2462
RP-62462-0^{III}



2472
F1RP-62472-0^{III}

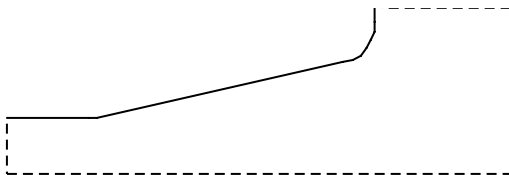

2503
RP-62503-0^{III}

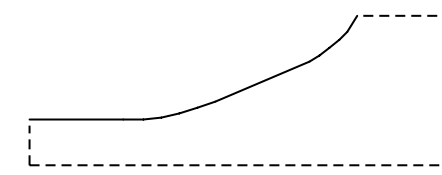

2526
RP-62526-0^{III}

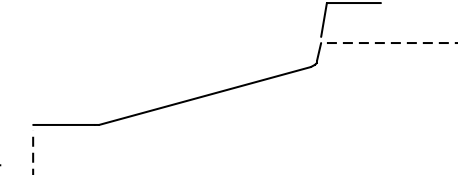

2535
RP-62535-0^{IV}

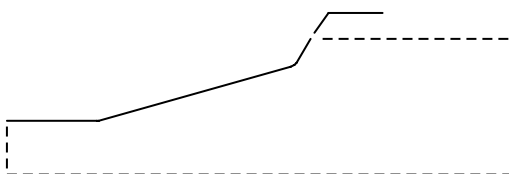

2539
RP-62539-0^{III}

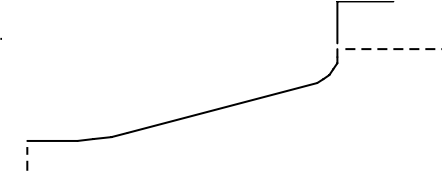

2600
RP-62600-0^{III}

RAISED PANEL

Bezel / 2-Curve

RAISED PANEL

Bezel / 2-Curve

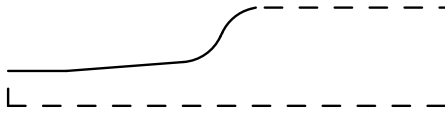

1348

RP-61348-0^{III}

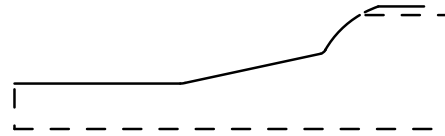

1970

RP-61970-0^{III}

RAISED PANEL

Bezel / 3-Curve

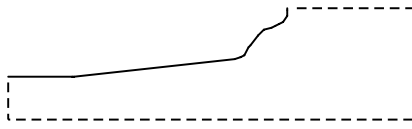

0390

RP-60390-0^{III}

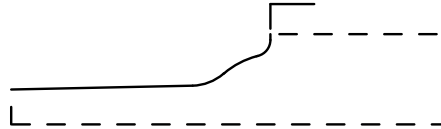

0400

RP-60400-0^{III}



0462

CC-60462-75^{III}

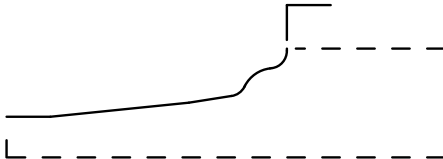

0479

RP-60479-0^{III}

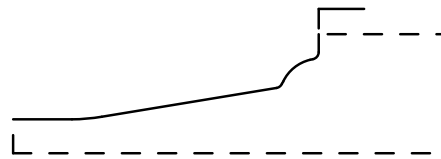

0480

RP-60480-0^{III}

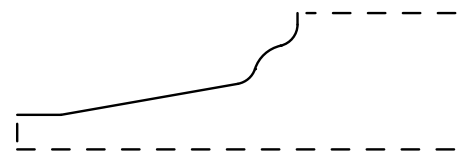

1029

RP-61029-0^{III}

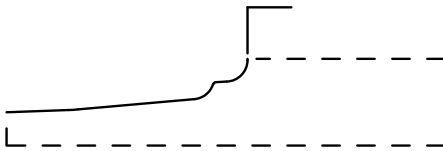

1031

RP-61031-0^{IV}

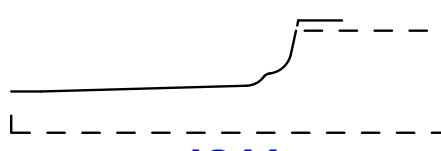

1244

RP-61244-12^{III}

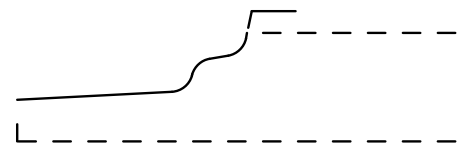

1247

RP-61247-12^V

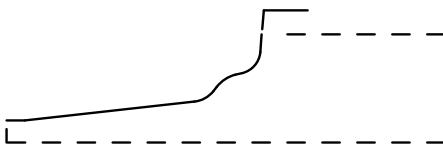

1469

RP-61469-0^{III}

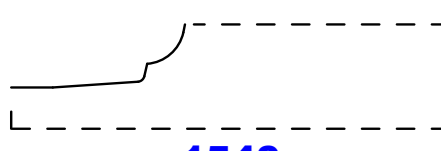

1540

RP-61540-12^V

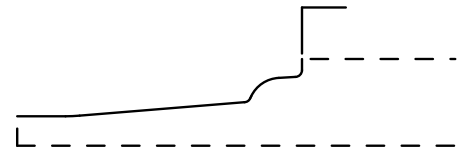

1568

RP-61568-0^V

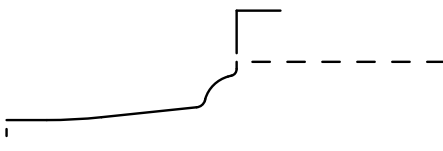

1678

RP-61678-0^V

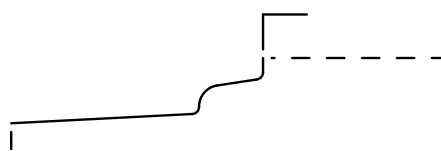

1691

RP-61691-0^V

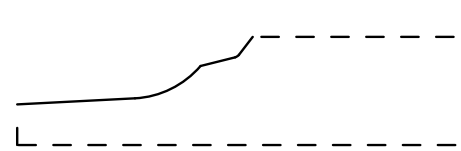

1694

RP-61694-12^V

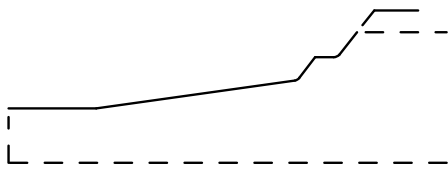

1723
FRP-61723-0^V

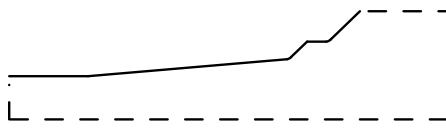

1724
FRP-61724-0^V

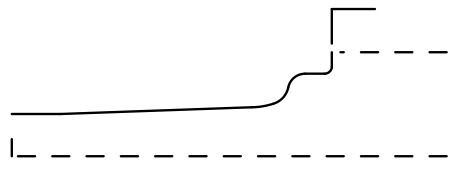

1742
FRP-61742-0^V



1813
RP-61813-0^V

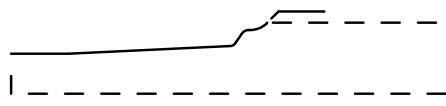

1935
RP-61935-0^{IV}

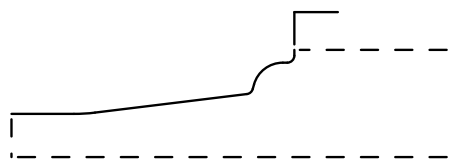

1996
RP-61996-0^V

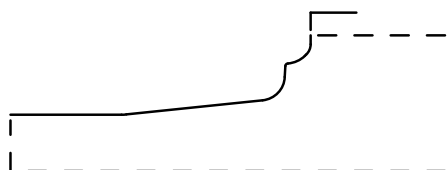

2046
F1RP-62046-0^{III}

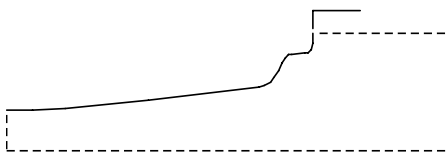

2118
F1RP-62118-0^V

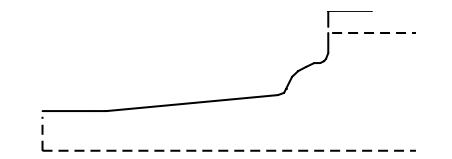

2139
RP-62139-0^V

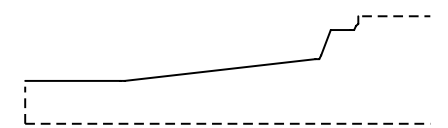

2307
RP-62307-0^V



2467
RP-72467-0^V

RAISED PANEL
Bezel / 4-Curve



1782
RP-61782-0^{VII}

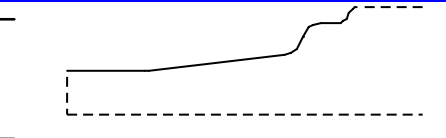

2018
RP-62018-0^V



2233
F1RP-62233-0^{VII}

RAISED PANEL
Bezel / 5-Curve

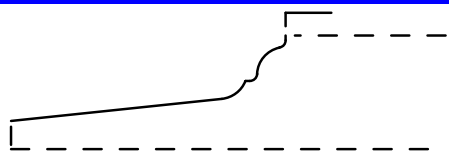

1735
RP-61735-0^V

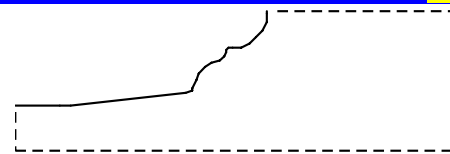

2263
RP-62263-12^{VII}

RAISED PANEL

Waterfall / 2-Curve

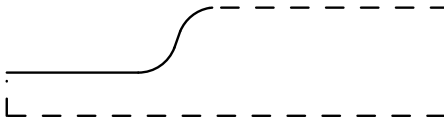

0329

RP-60329-0^{III}

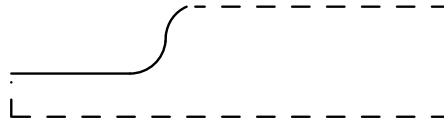

0452

RP-60452-0^{III}



0514

AA-60514-55^{III}

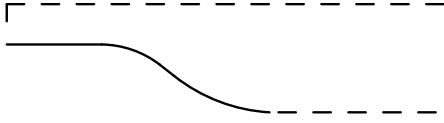

0650

RP-60650-0^{III}

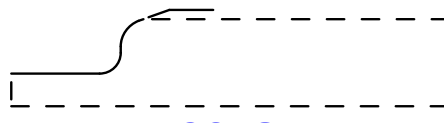

0672

RP-60672-0^{III}

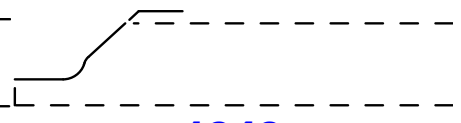

1046

RP-61046-12^{III}

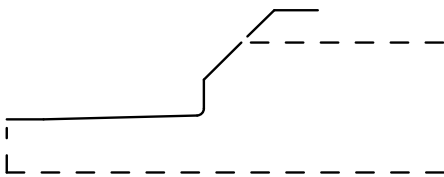

1496

RP-61496-0^{IV}



1498

RP-61498-0^{IV}

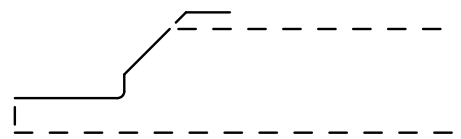

1659

RP-51659-0^{IV}



1664

RP-51664-0^{IV}

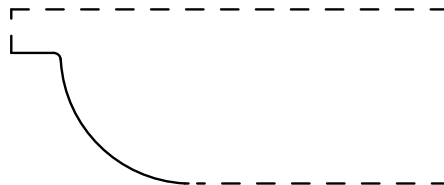

1712

FRP-61712-0^{IV}

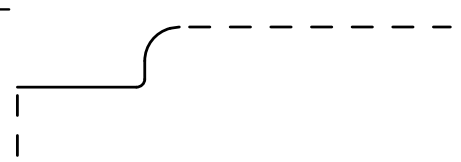

1731

RP-61731-0^{IV}

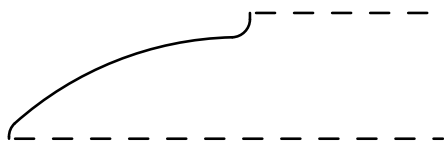

1791

RP-61791-0^{IV}



2034

RP-62034-0^{III}

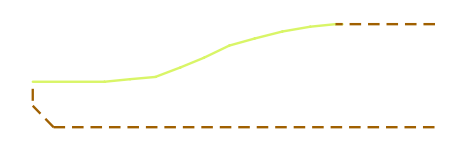

2422

RP-62422-0^{III}



2471

RP-62471-0^{III}

RAISED PANEL

Waterfall / 3-Curve

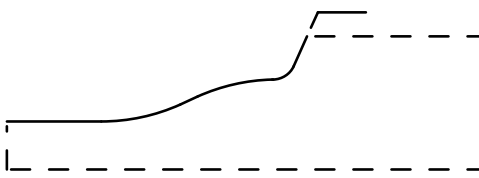

0280
RP-60280-0^{II}

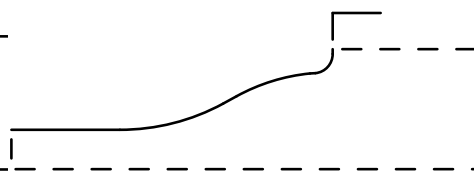

0281
RP-60281-0^{III}

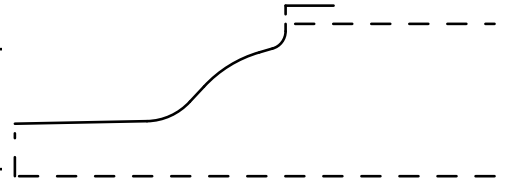

0324
RP-60324-0^{II}

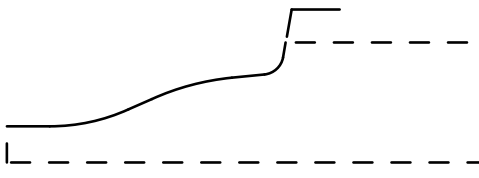

0388
RP-60388-0^{II}

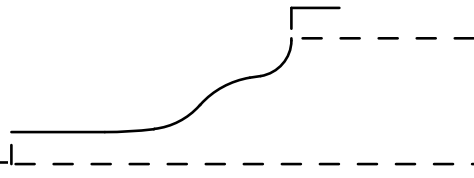

0389
RP-60389-0^{III}

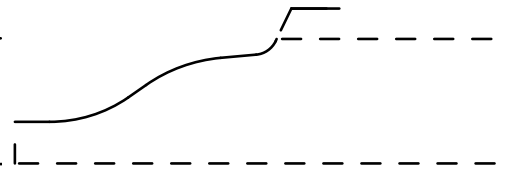

0409
RP-60409-0^{II}

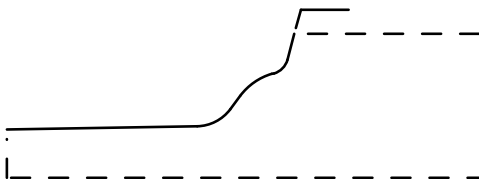

0430
RP-60430-0^{II}

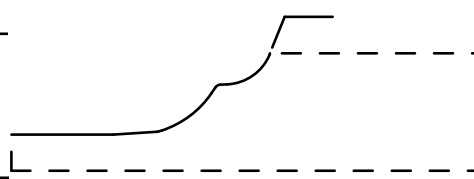

0432
RP-60432-0^{III}

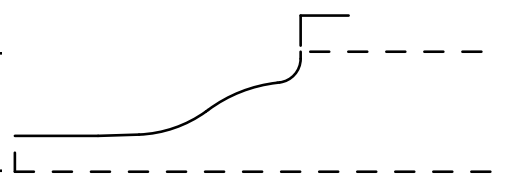

0444
RP-60444-0^{III}

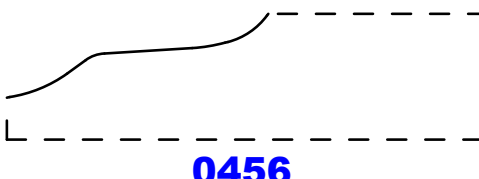

0456
RP-60456-0^{II}

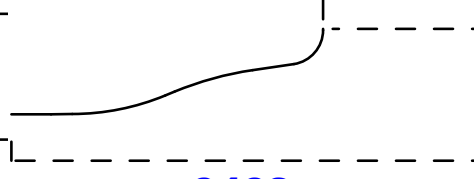

0468
RP-60468-0^{II}

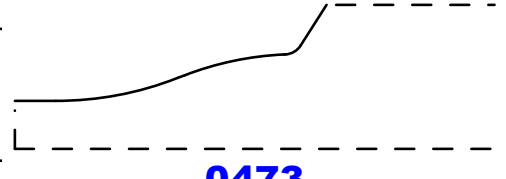

0473
RP-60473-0^{III}

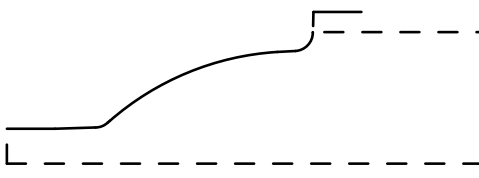

0485
RP-60485-0^{III}

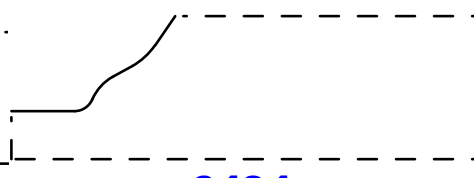

0494
AA-60494-40^{III}

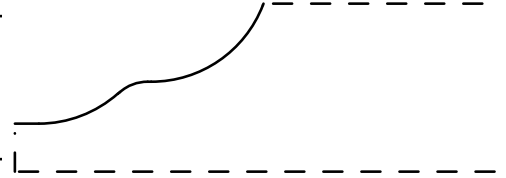

0503
RP-60503-0^{III}

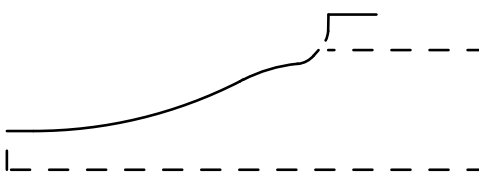

0504
RP-60504-0^{II}

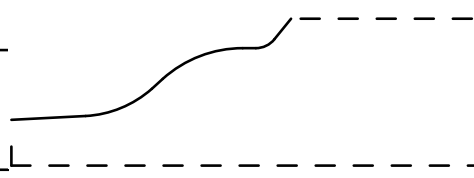

0534
RP-60534-0^{II}

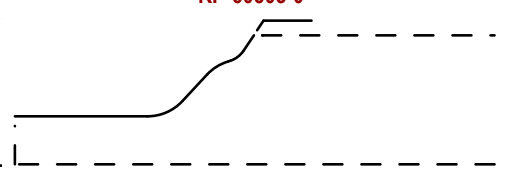

0544
RP-60544-12^{II}

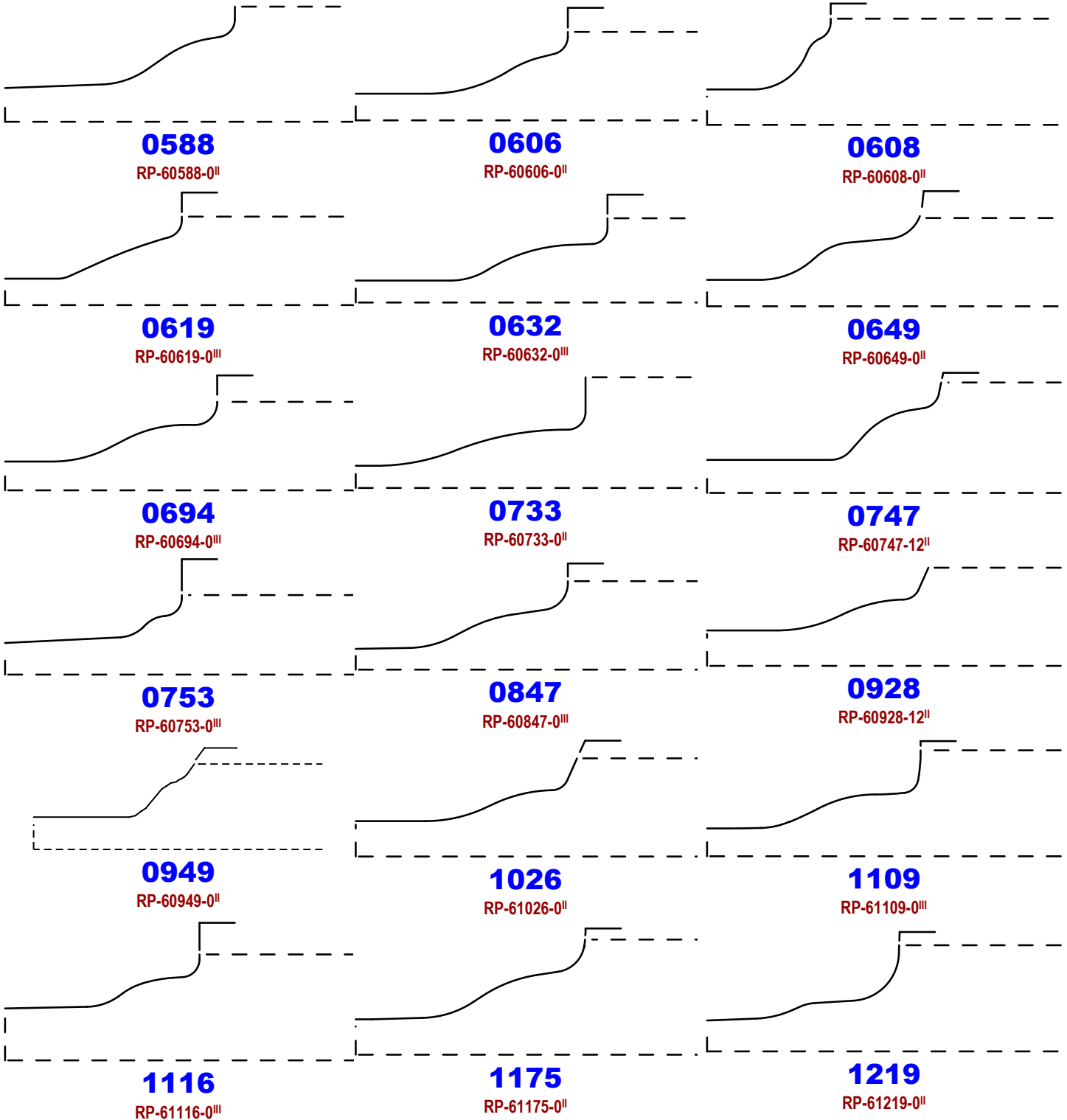

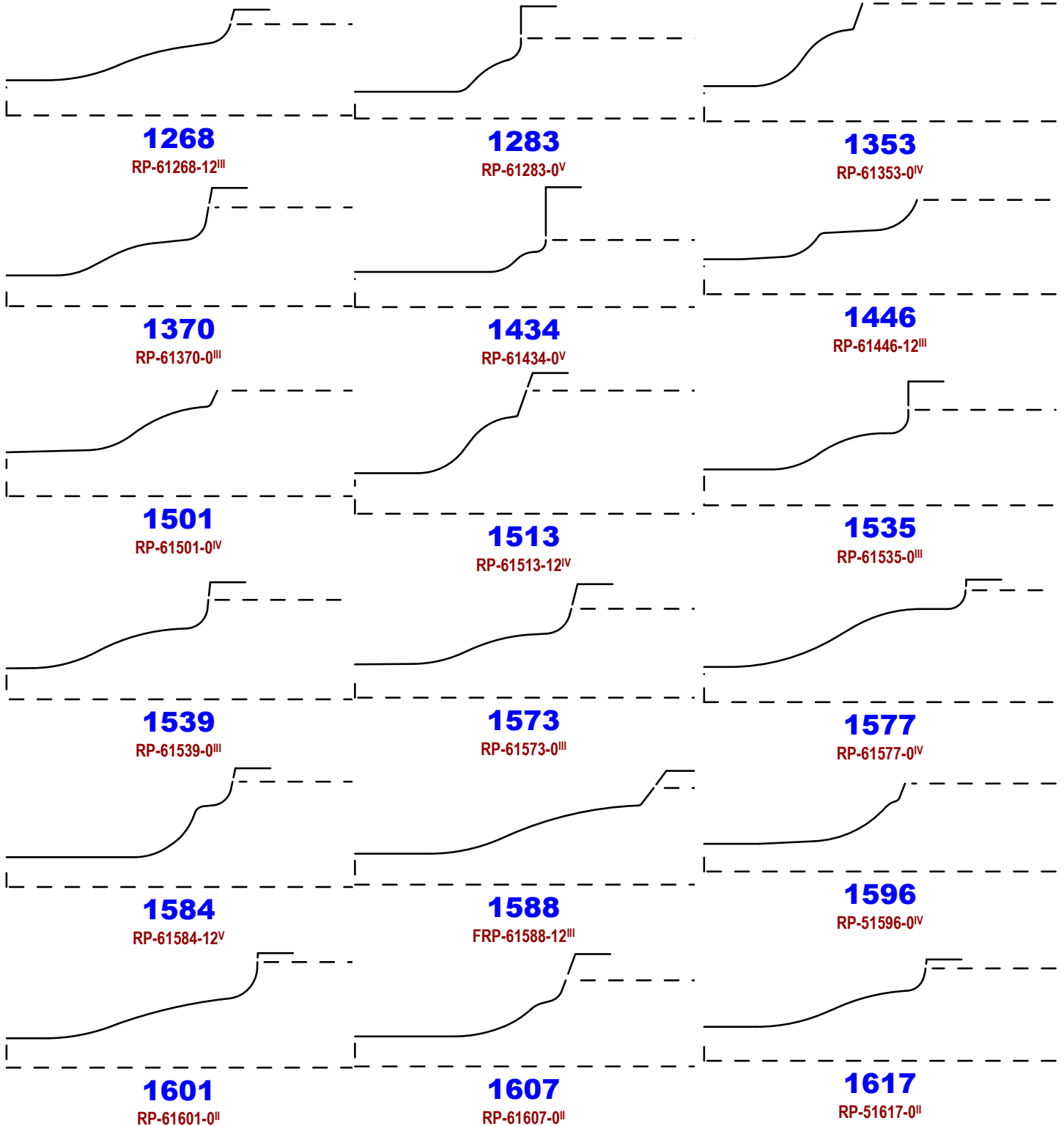

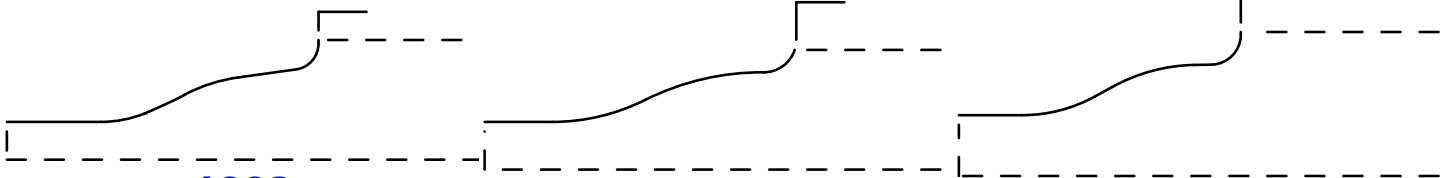

1662
RP-51662-0^{II}

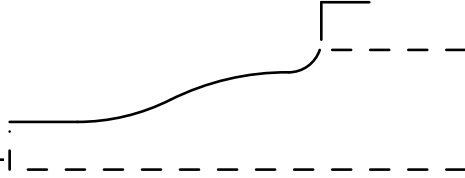

1666
RP-61666-0^{II}

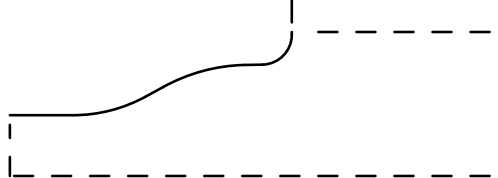

1684
RP-61684-0^{II}

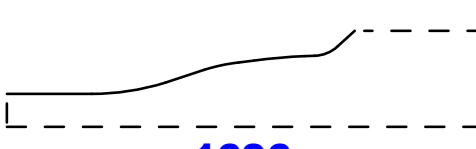

1696
RP-61696-0^{IV}



1729
RP-61729-0^{III}

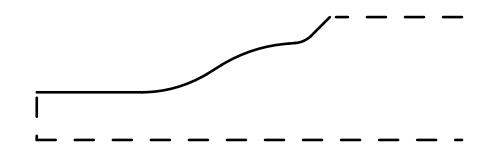

1769
RP-61769-0^{II}

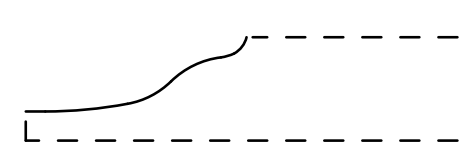

1773
RP-61773-12^{II}

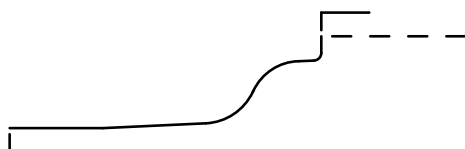

1812
RP-61812-0^{IV}



1815
RP-61815-0^{III}



1819
RP-61819-0^{IV}

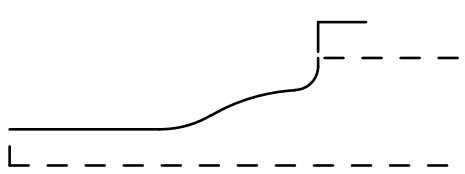

1824
RP-61824-0^{III}

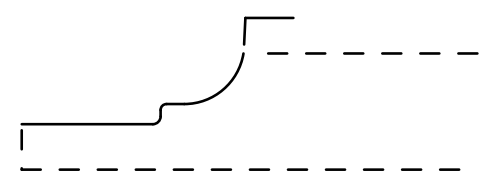

1838
RP-61838-0^{III}



1902
RP-61902-0^{IV}

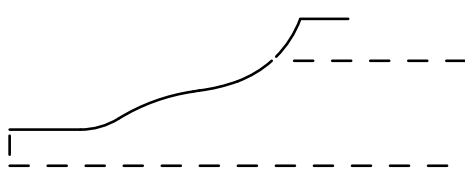

1907
RP-61907-0^{II}

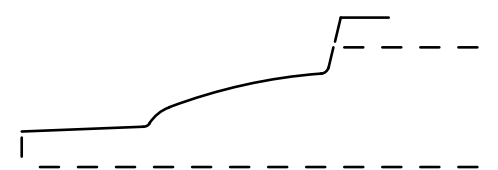

1934
F1RP-61934-0^{IV}

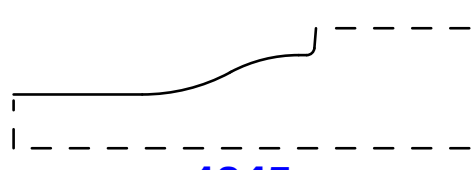

1945
RP-61945-0^{III}

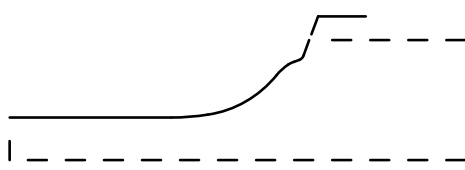

1998
RP-61998-0^{III}

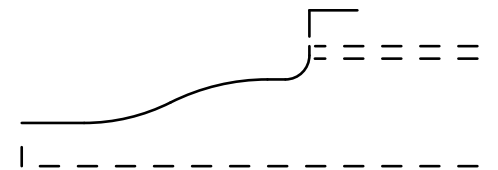

2008
RP-62008-0^{III}

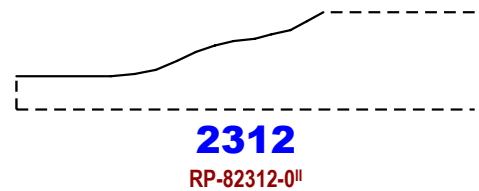
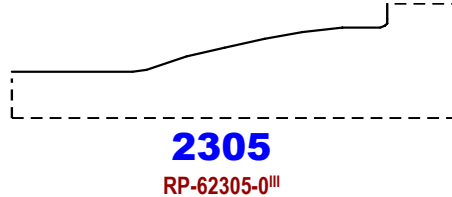
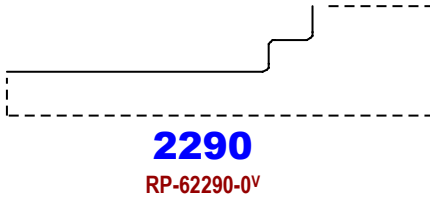
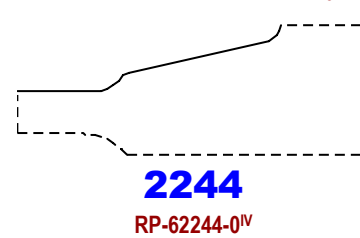
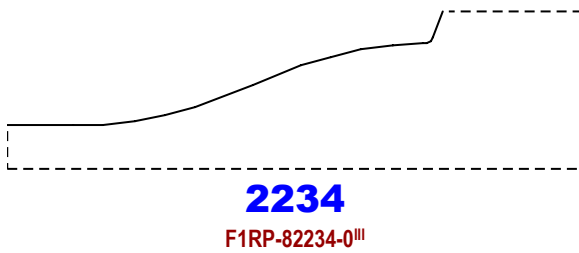
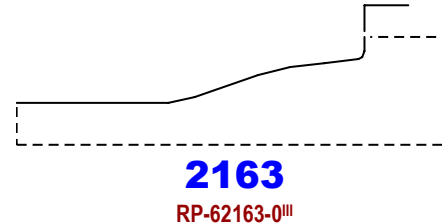
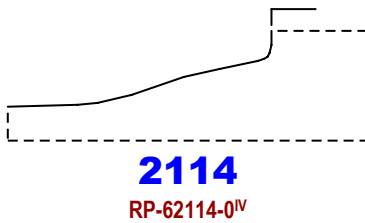
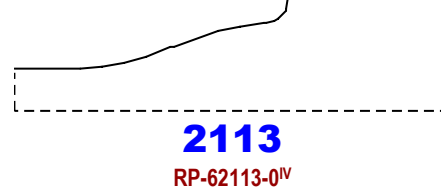
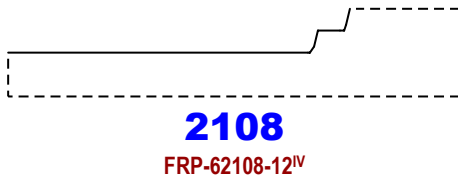
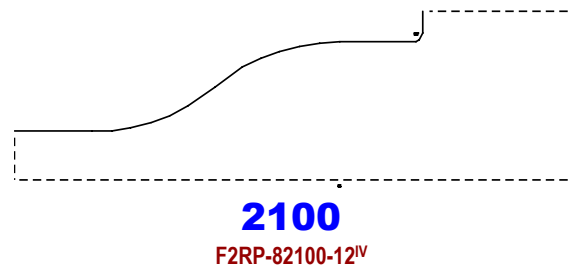
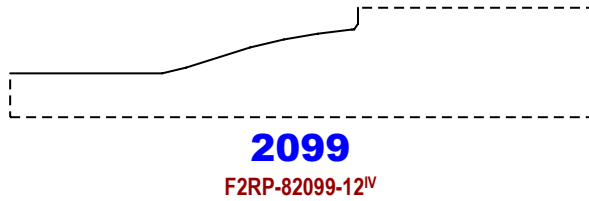
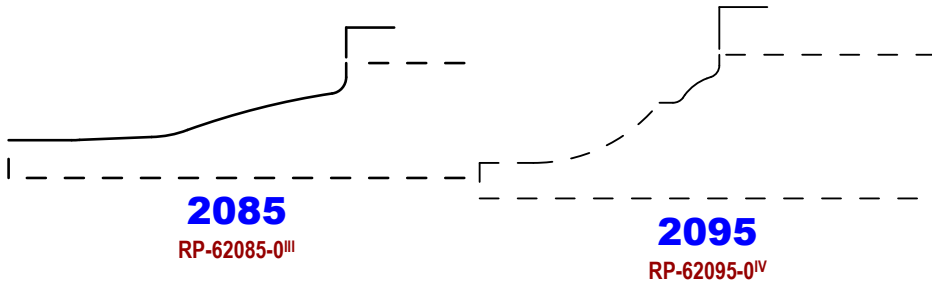

RAISED PANEL

Waterfall / 3-Curve

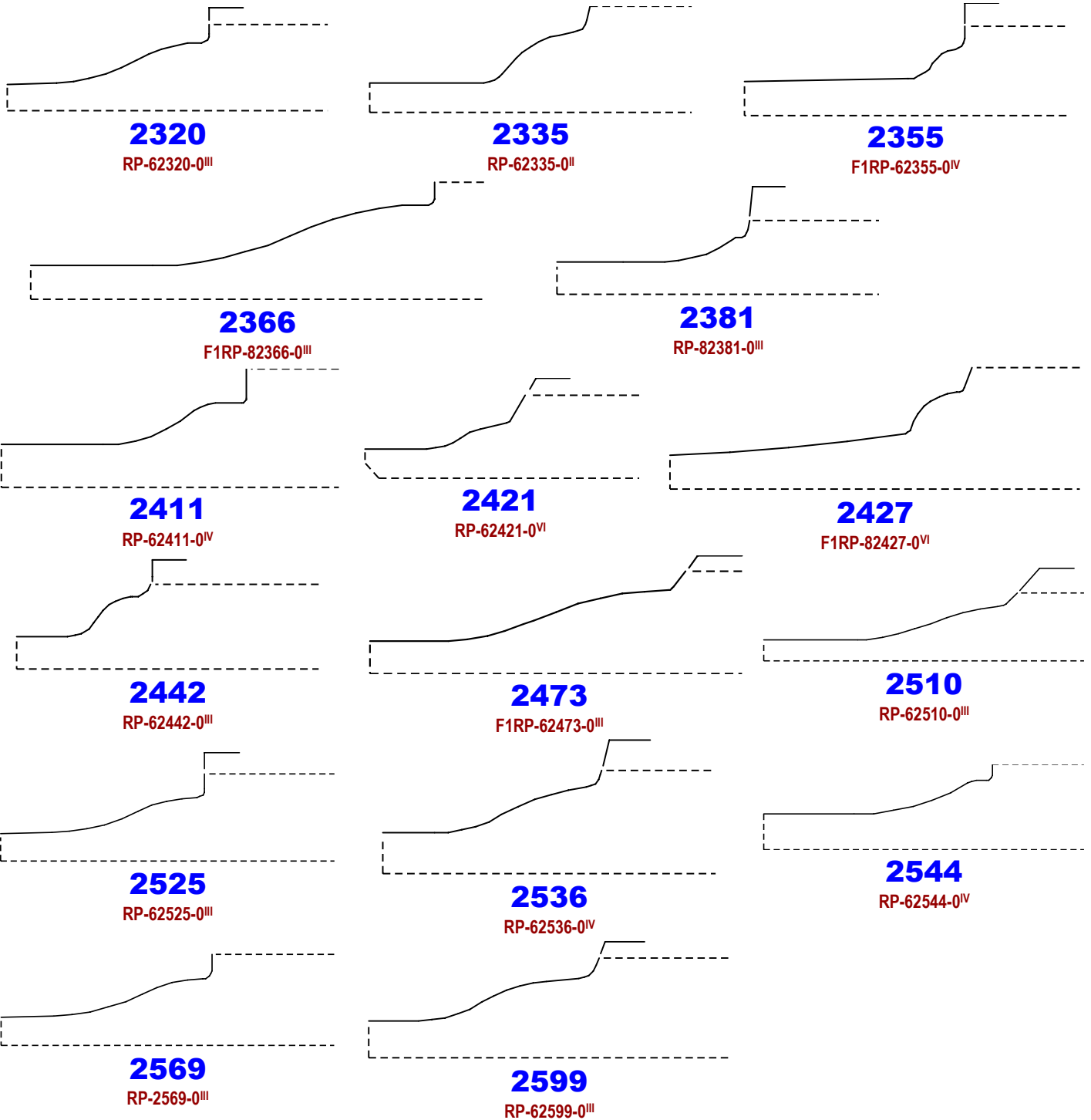

RAISED PANEL

Waterfall / 4-Curve

RAISED PANEL

Waterfall / 4-Curve

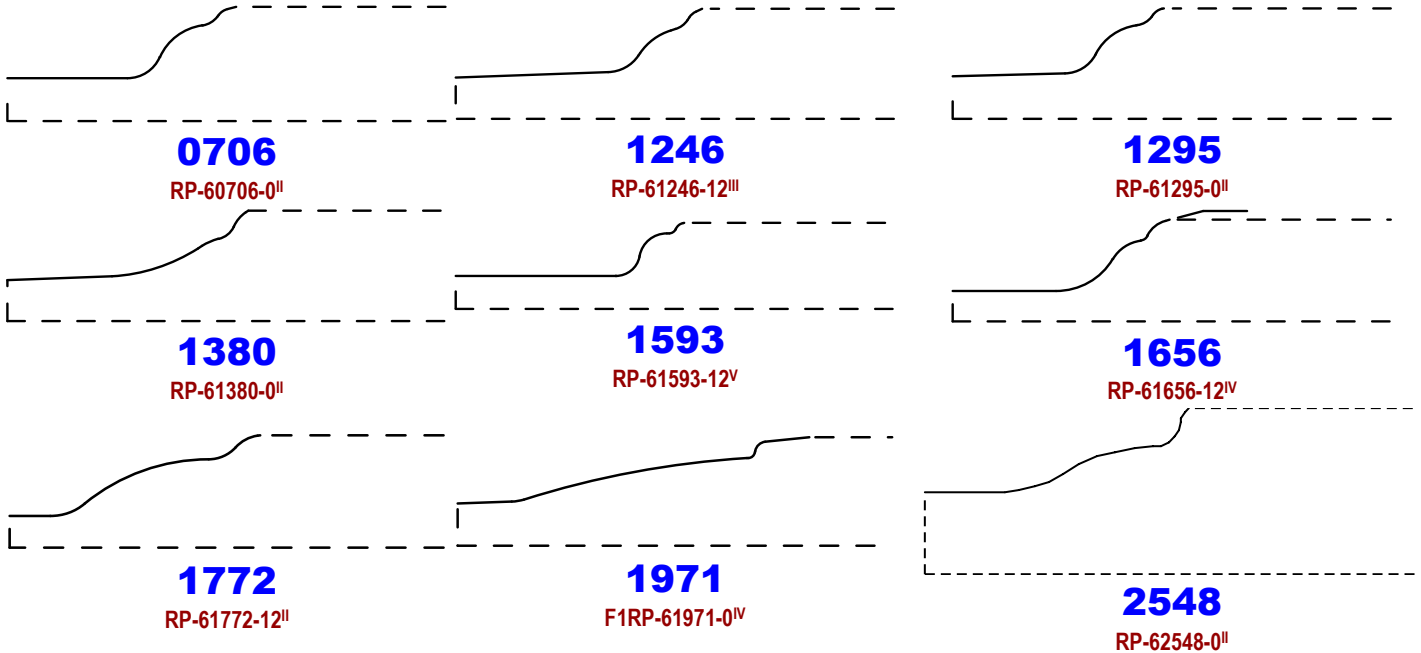

RAISED PANEL

Waterfall / 5-Curve

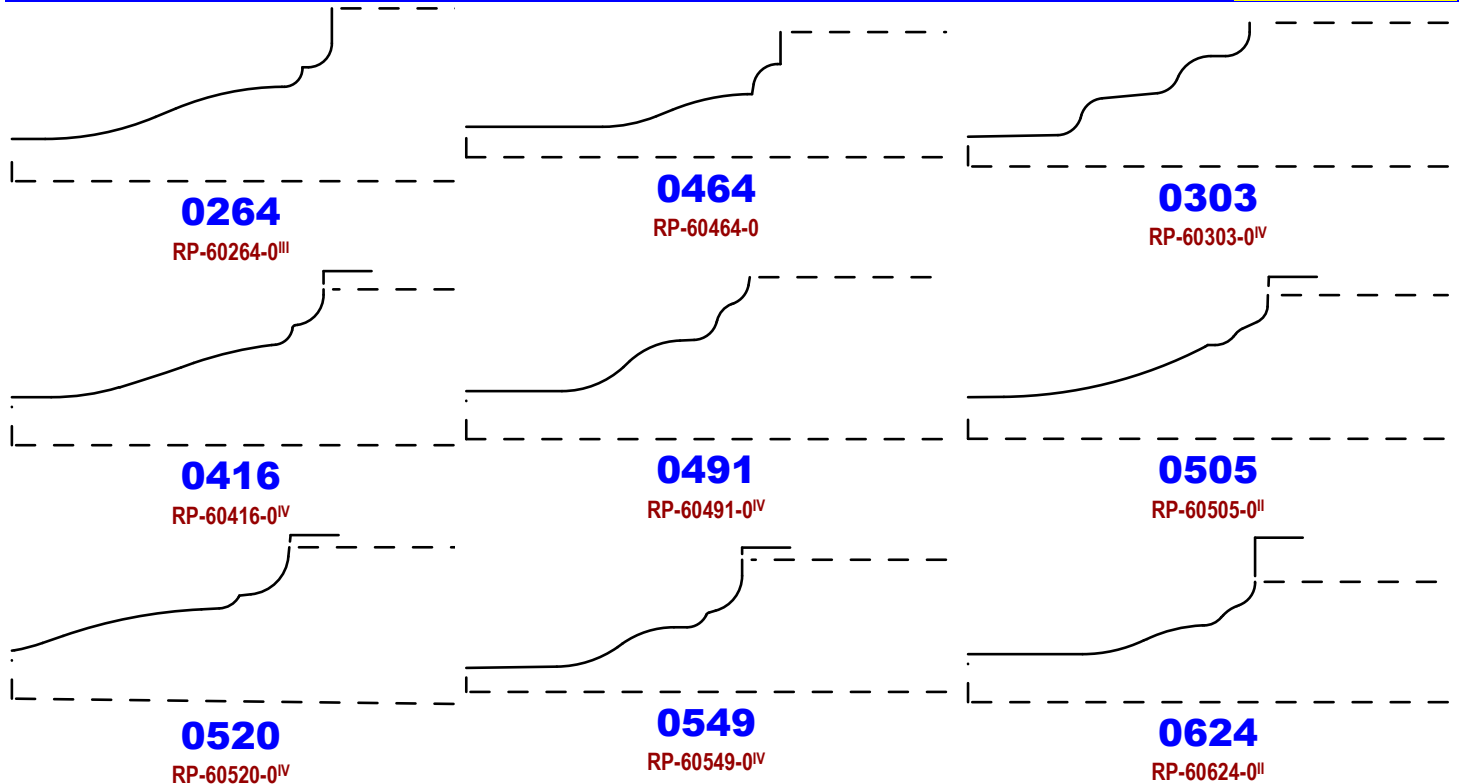

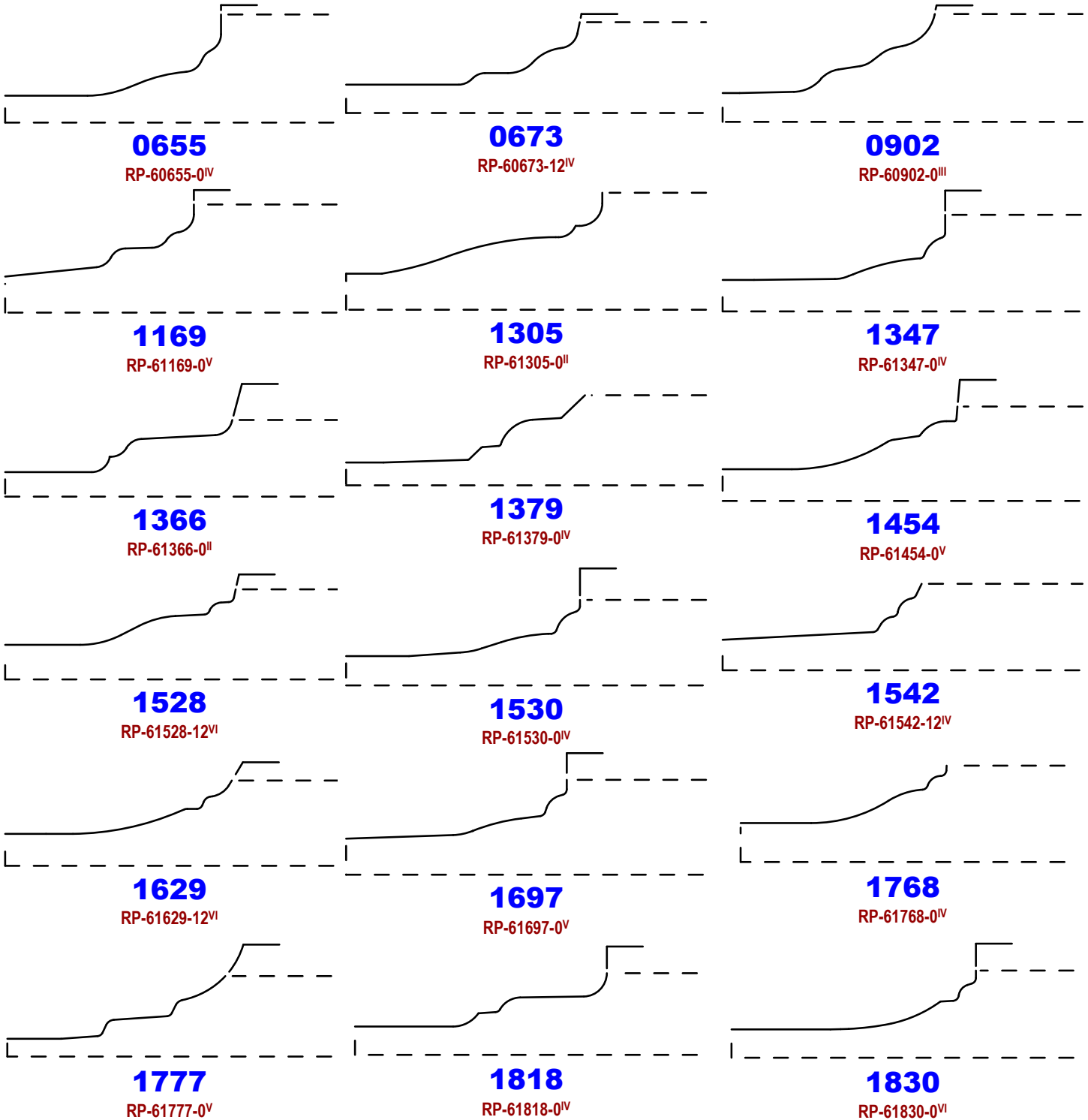

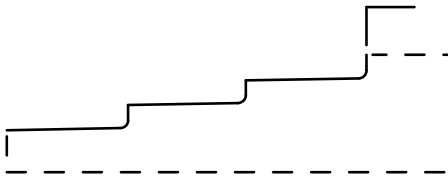

1832
FRP-61832-0^V

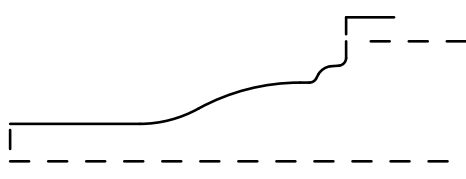

1833
RP-61833-0^V

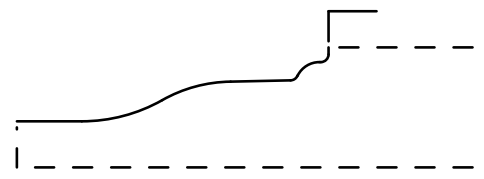

1847
RP-61847-0^V

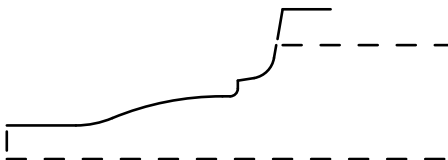

1852
RP-61852-0^V

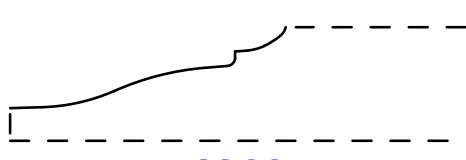

1869
RP-61869-0^V

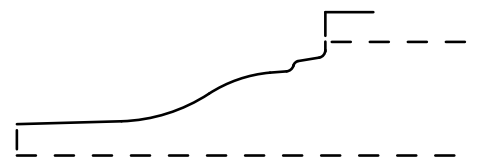

1933
RP-61933-0^V

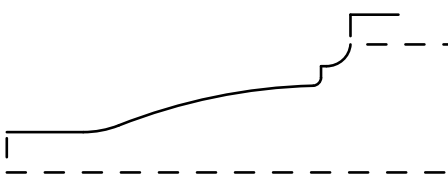

1959
RP-61959-0^V

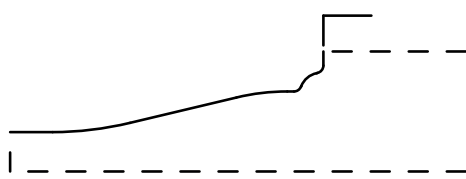

1966
RP-61966-0^{VII}



1968
FRP-61968-0^{III}

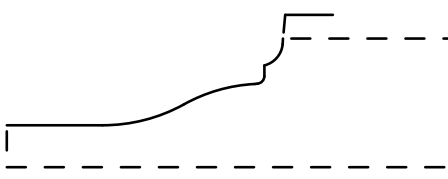

2020
RP-62020-0^V

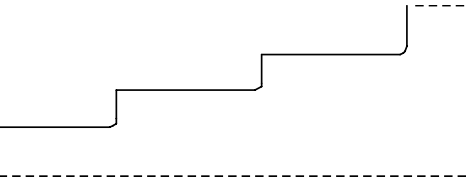

2102
F2RP-82102-12^V

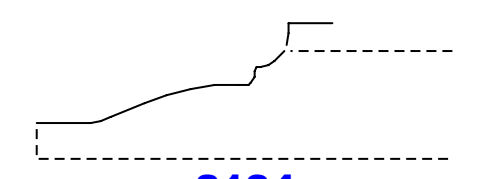

2184
RP-62184-0^V

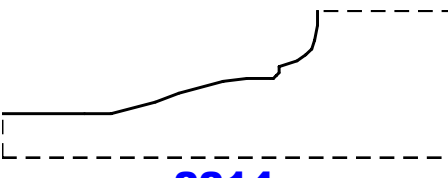

2214
RP-62214-0^{IV}

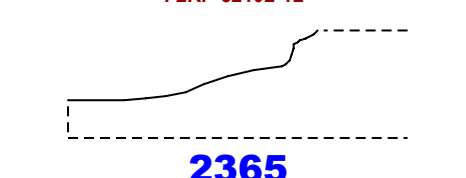

2365
RP-62365-0^{IV}

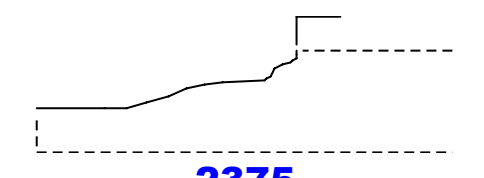

2375
RP-62375-0^{VI}

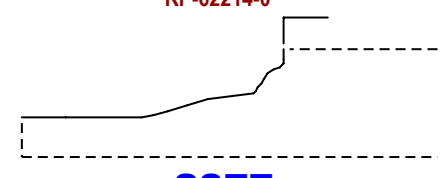

2377
RP-62377-0^{VI}

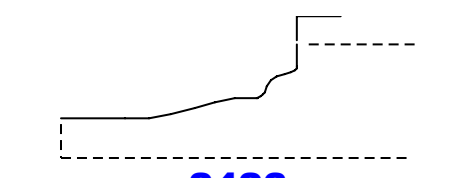

2423
RP-62423-0^{VI}

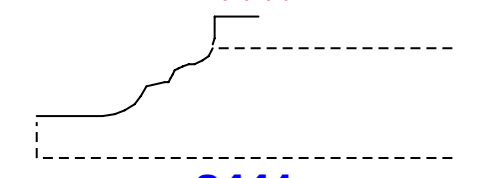

2441
RP-62441-0^V

RAISED PANEL

Waterfall / 5-Curve

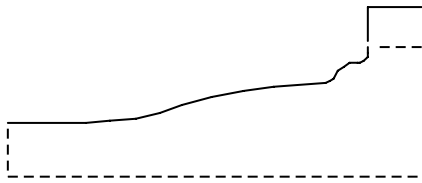

2507

RP-62507-0^{VI}

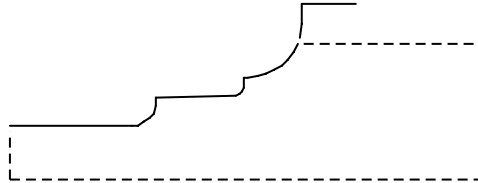

2534

RP-62534-0^{VI}

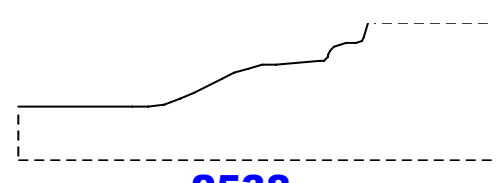

2538

RP-62538-0^{VI}

RAISED PANEL

Waterfall / 7-Curve

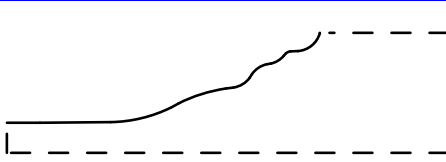

1279

RP-61279-0^{II}

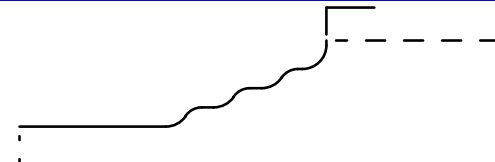

1294

RP-61294-0^{III}

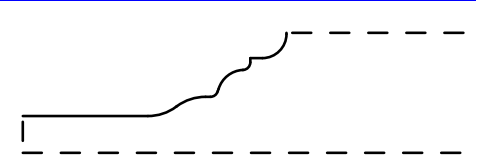

1594

RP-61594-12^{VII}

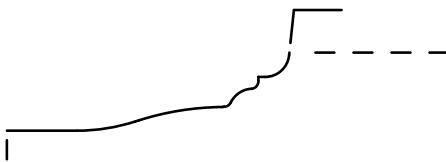

1675

RP-61675-0^{VI}

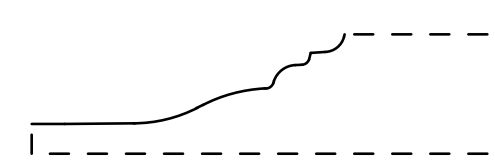

1783

RP-61783-0^{VII}

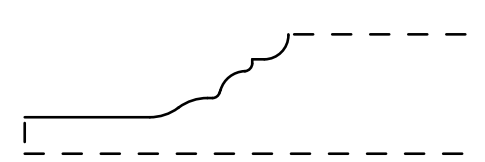

1795

RP-61795-65^V

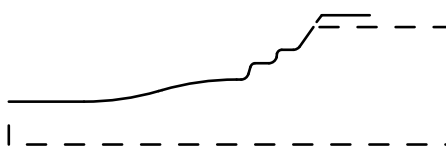

1928

RP-61928-0^{VI}

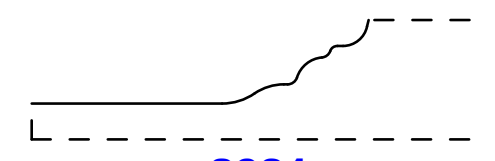

2081

F1RP-62081-12^{VII}

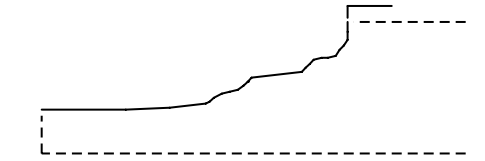

2136

RP-62136-0^V

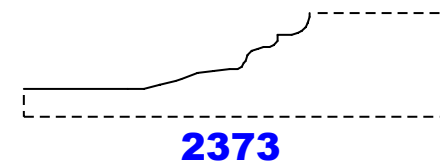

2373

RP-62373-0^{VII}

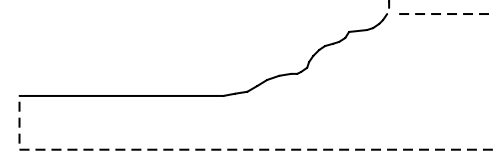

2564

RP-62564-0^{VI}

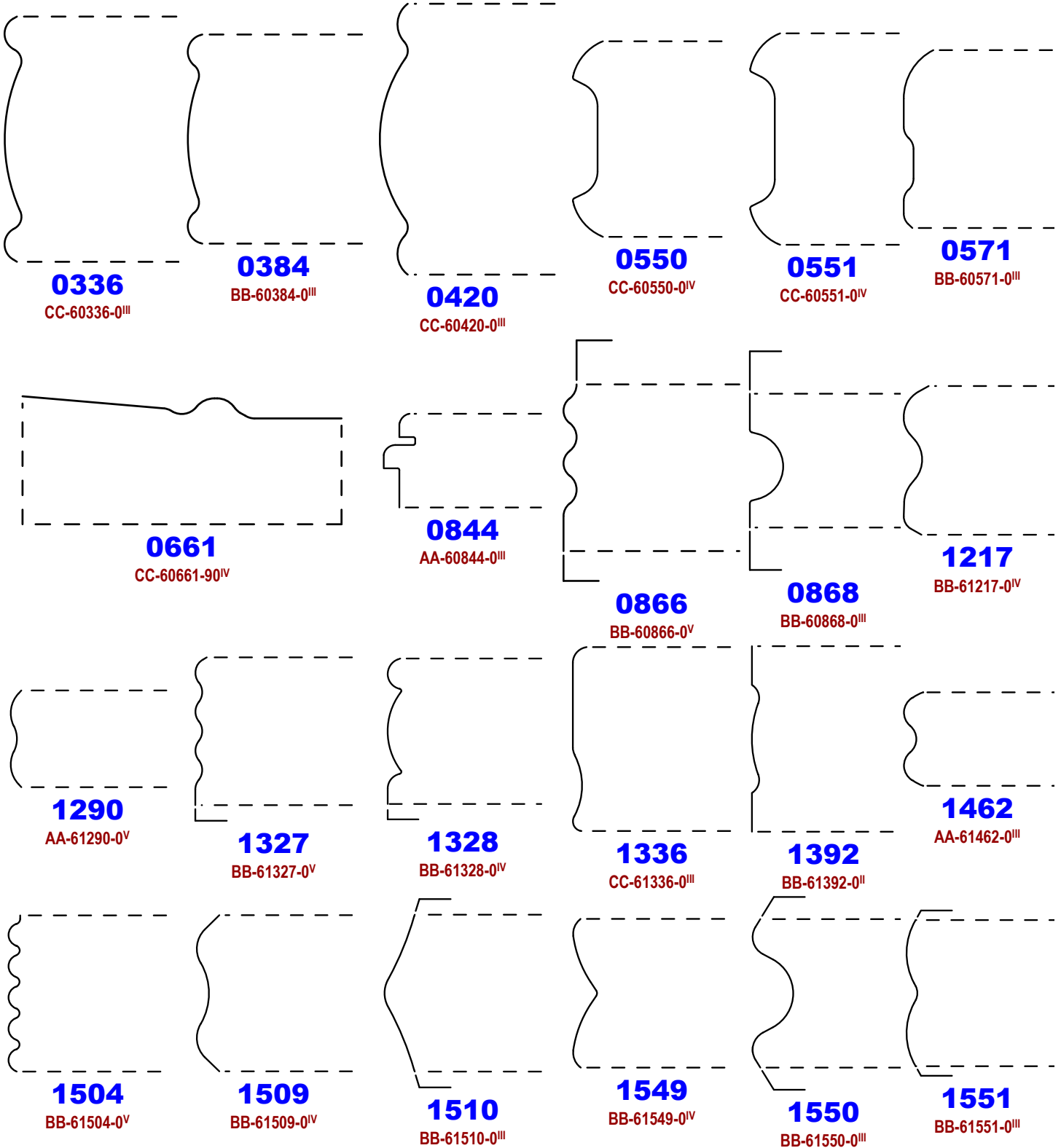

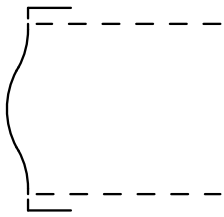

1556

AA-61556-0^{II}

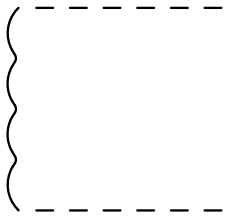

1561

BB-61561-0^V

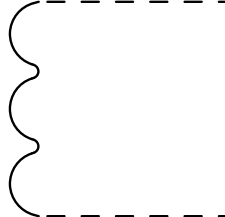

1711

BB-61711-0^V

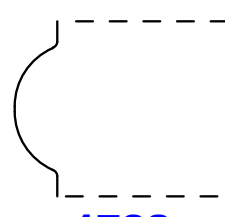

1732

AA-61732-0^V

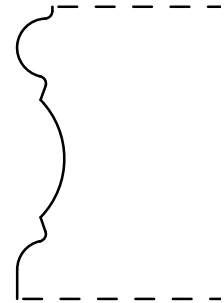

1785

BB-61785-0^{VII}

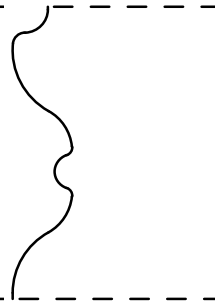

1786

BB-61786-0^{VII}

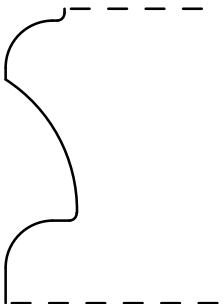

1787

BB-61787-0^{VI}

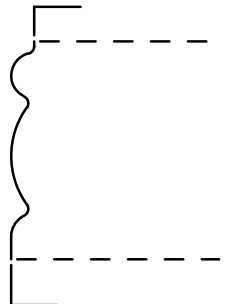

1788

BB-61788-0^V

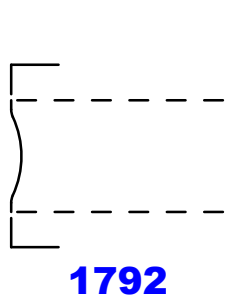

1792

AA-61792-0^{II}

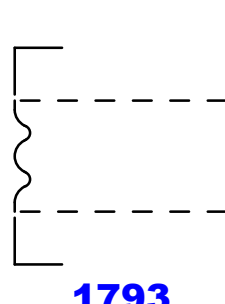

1793

AA-61793-0^V

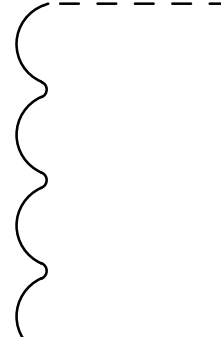

1904

CC-61904-0^V

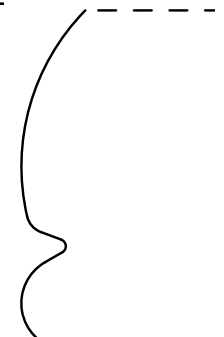

1910

CC-61910-0^V

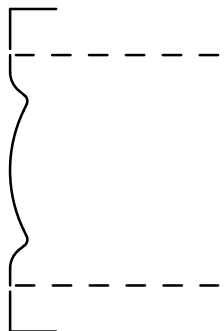

1911

BB-61911-0^V

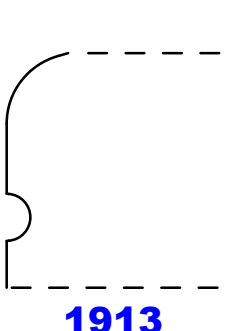

1913

BB-61913-0^V

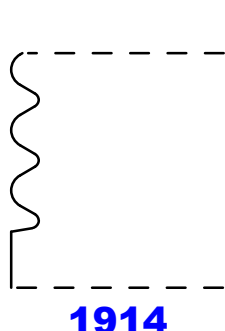

1914

BB-61914-0^V

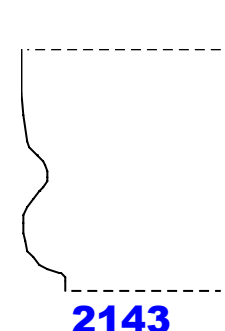

2143

BB-62143-0^V

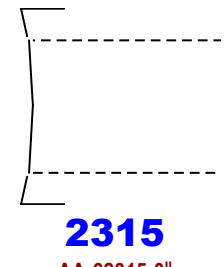

2315

AA-62315-0^{II}

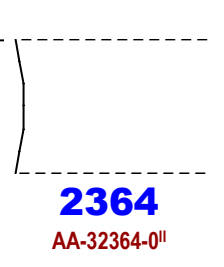

2364

AA-32364-0^{II}

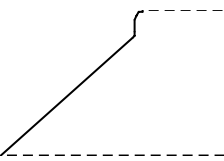

2487

FBA-52487-0^V



2522

AA-62522-0^V



2529

FBA-52529-0^V

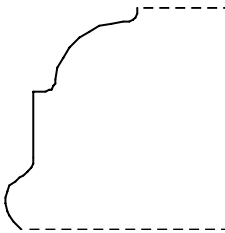

2607

FBC-62607-0^{VII}

WATERFALL EDGE

3-Curve Rolling

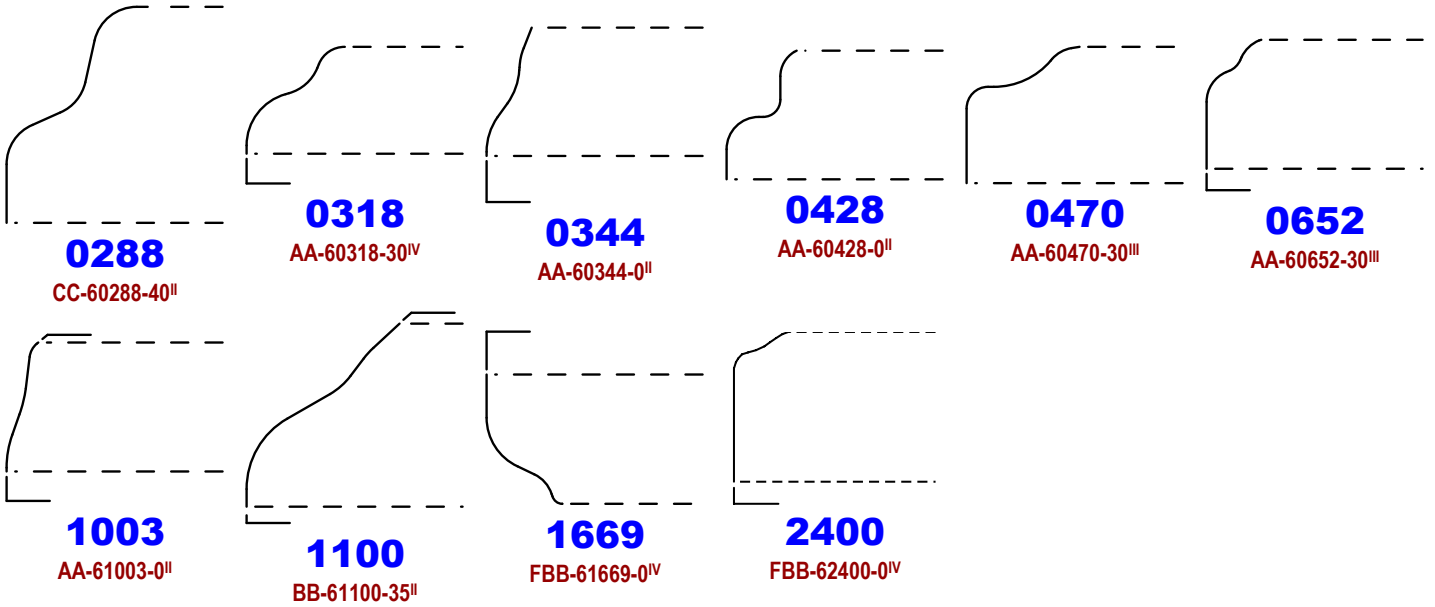

WATERFALL EDGE

3-Curve 2-Bead

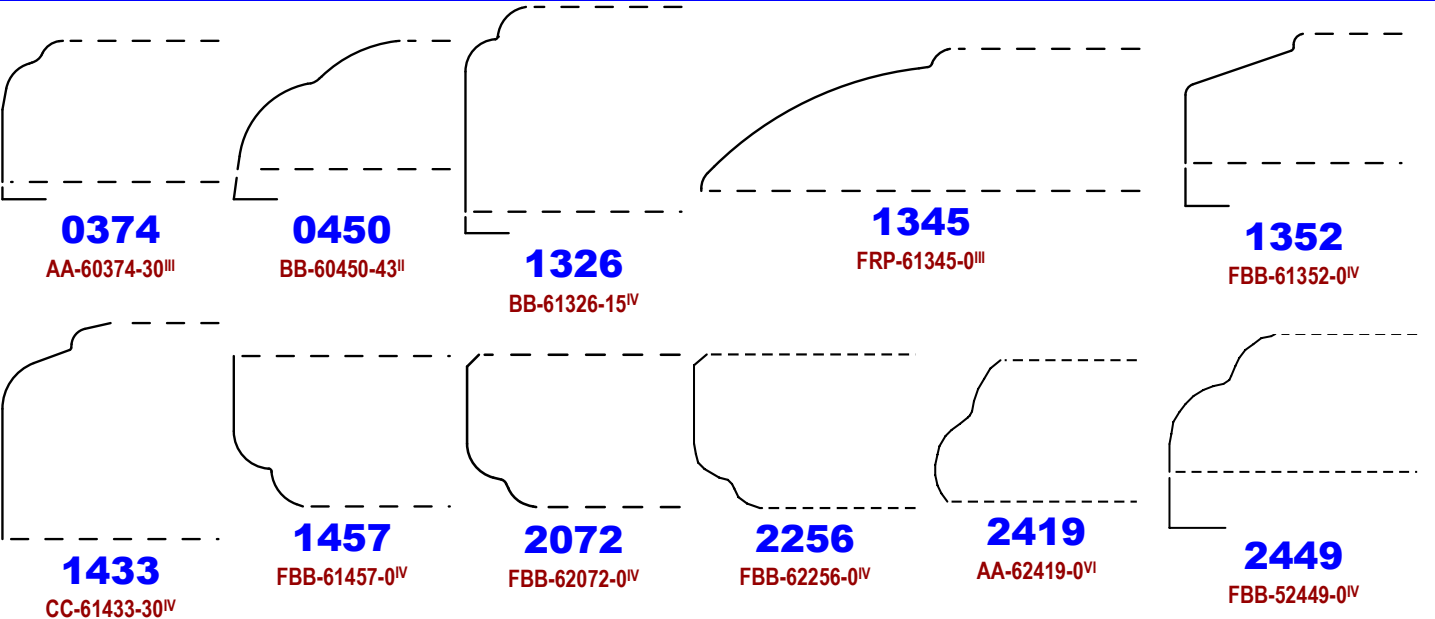

WATERFALL EDGE

3-Curve S-Bead

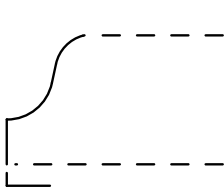

0437
AA-60437-20^{III}

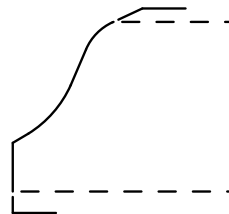

1537
FBB-51537-0^{III}

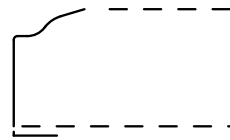

1624
AA-61624-15^{IV}



1637
AA-61637-20^{IV}

WATERFALL EDGE
4-Curve Rolling

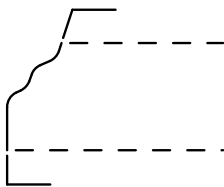

0063
AA-60063-20^{III}

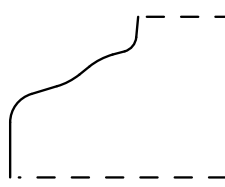

0064
AA-60064-40^{IV}

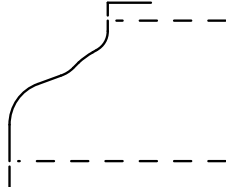

0126
AA-60126-20^{II}

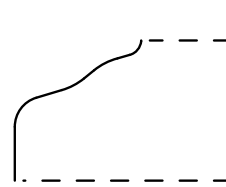

0149
AA-60149-40^{III}



0157
AA-60157-25^{III}

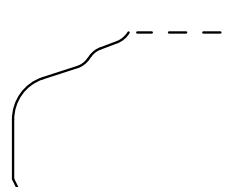

0158
AA-60158-33^{III}

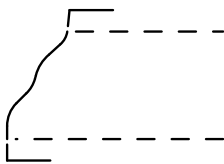

0186
AA-60186-20^I

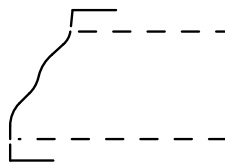

0187
AA-60187-0^{II}

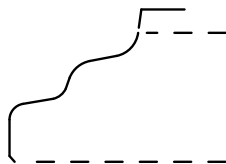

0201
AA-60201-40^{III}

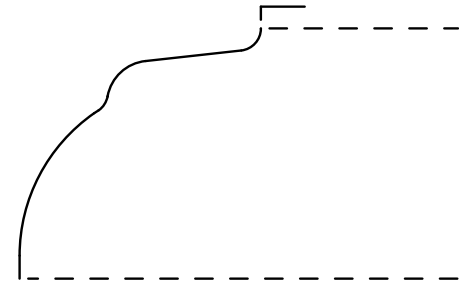

0209
CC-60209-45^{III}

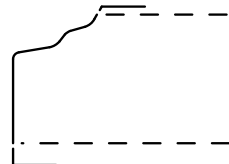

0227
AA-60227-30^{III}

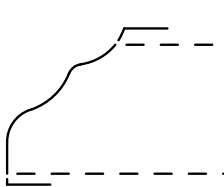

0238
AA-60238-35^{III}

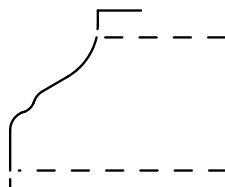

0248
AA-60248-30^{III}

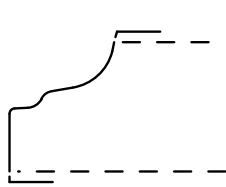

0251
AA-60251-35^{III}

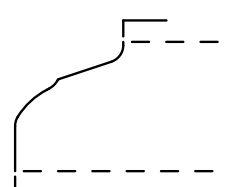

0277
AA-60277-30^{III}

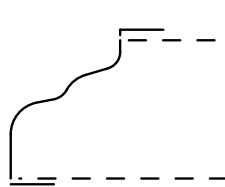

0278
AA-60278-33^{III}

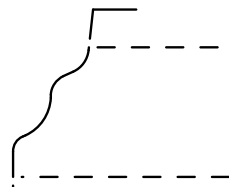

0297
AA-60297-20^{III}

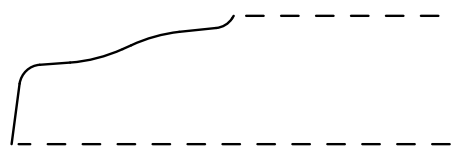

0301
BB-60301-55^{III}

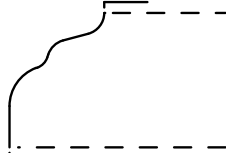

0319
AA-60319-35^{III}

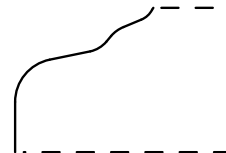

0337
AA-60337-35^{III}



0369
AA-60369-30^{III}



0380
AA-60380-25^{IV}

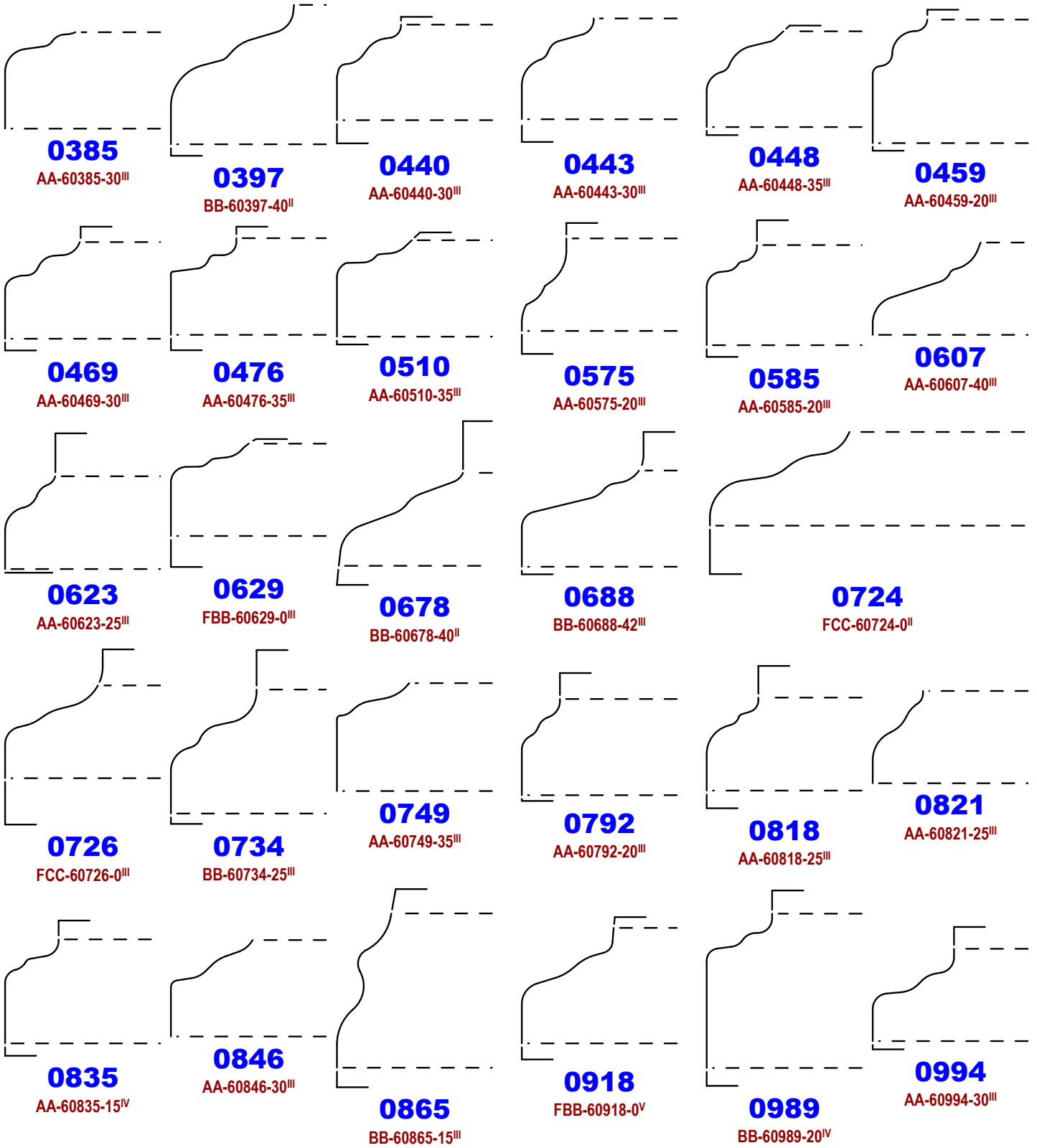

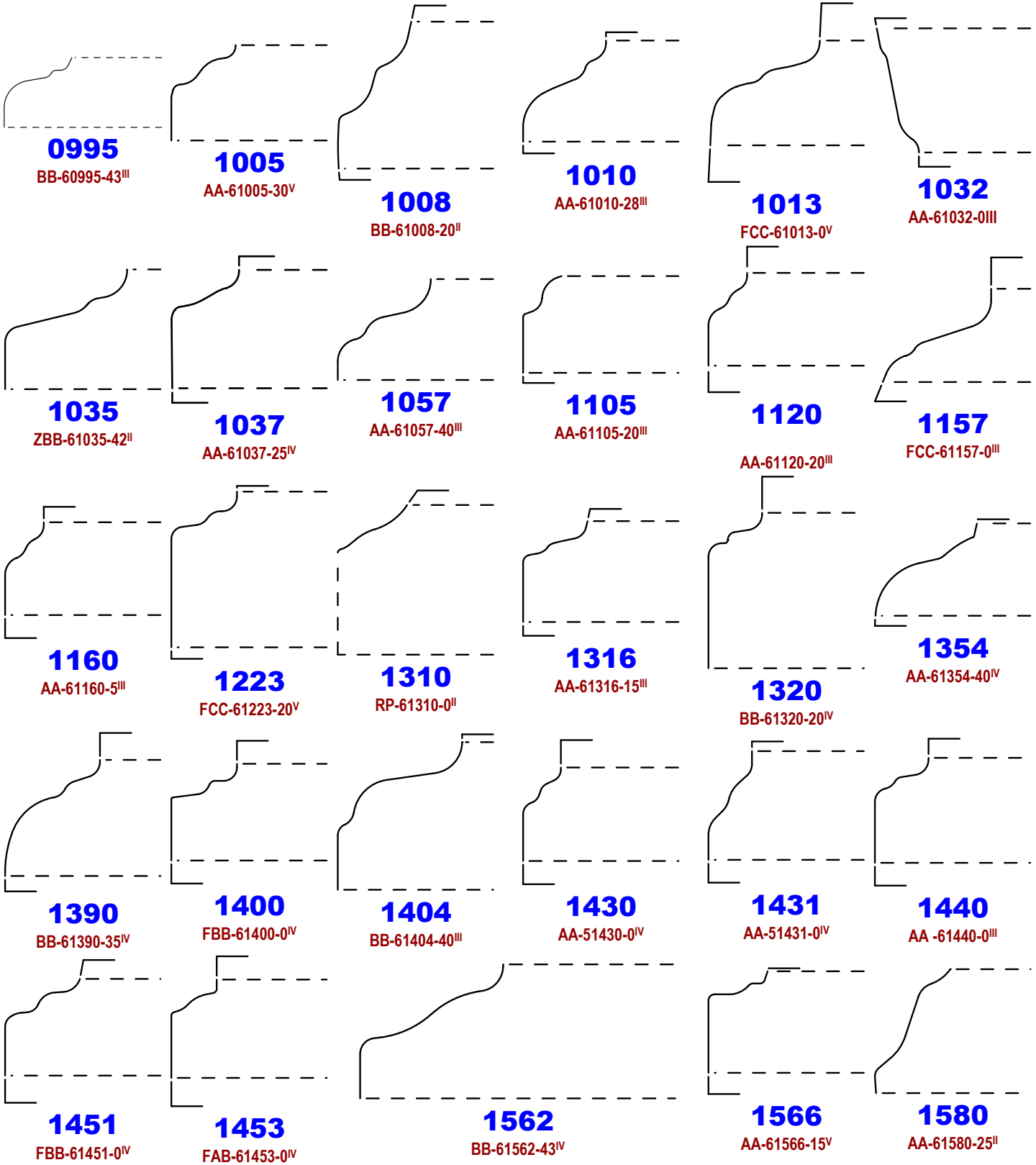

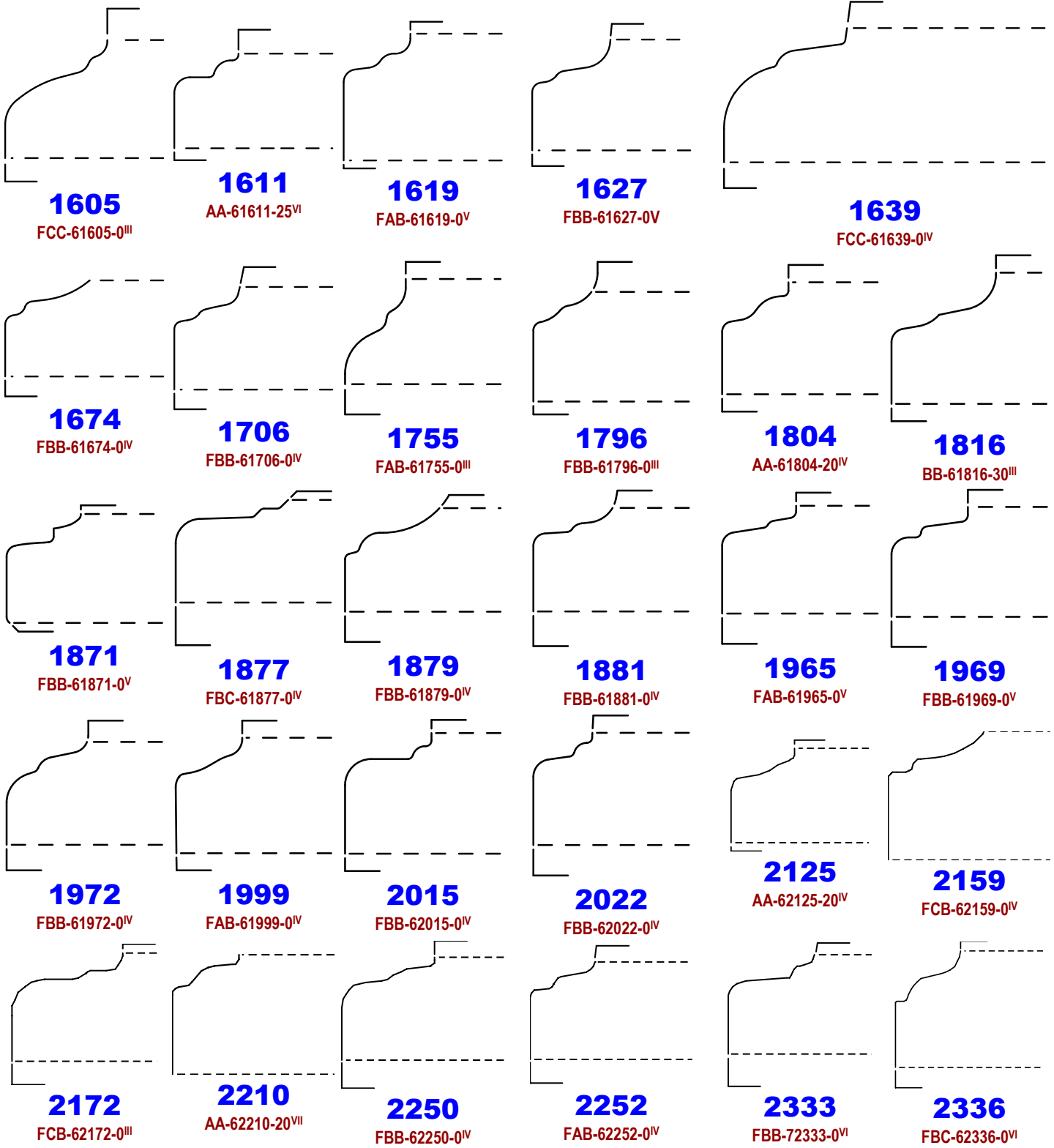

WATERFALL EDGE

4-Curve Rolling

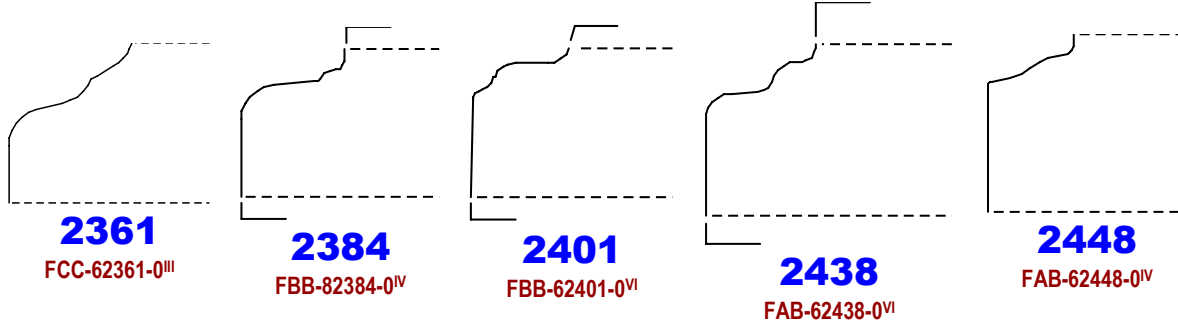

WATERFALL EDGE

4-Curve Roman Bead

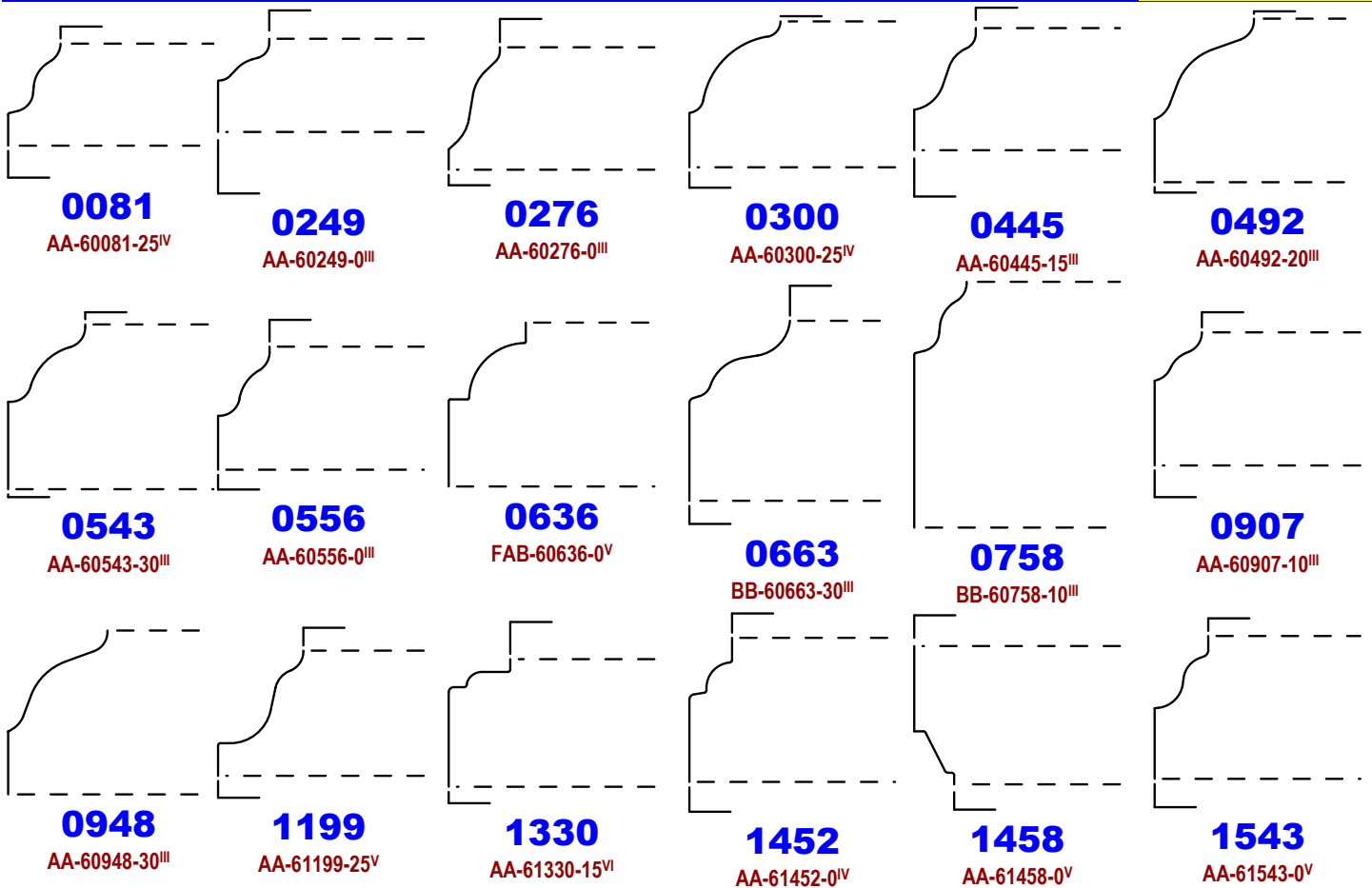

WATERFALL EDGE

4-Curve Roman Bead

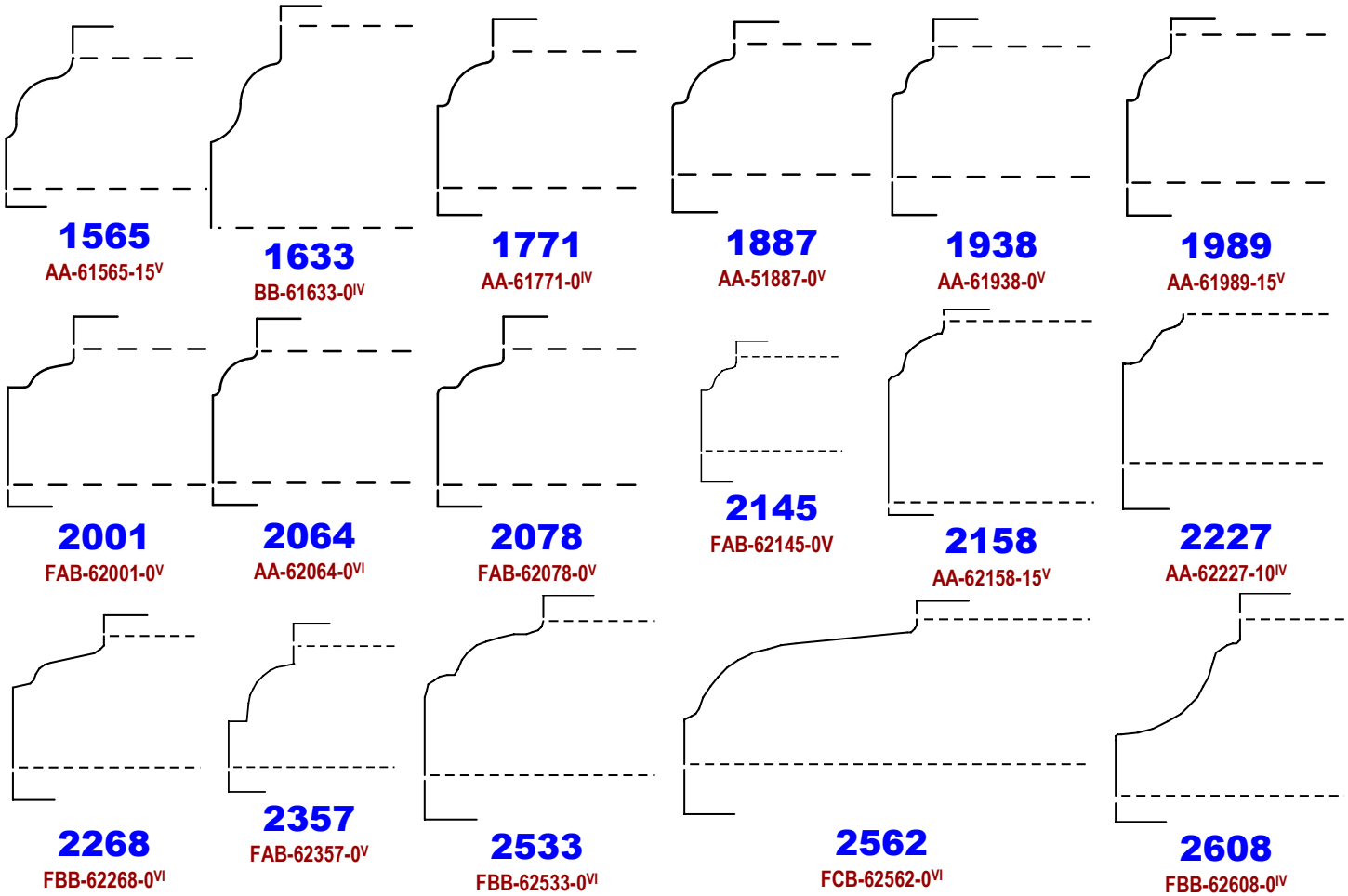

WATERFALL EDGE

4-Curve / Corinthian

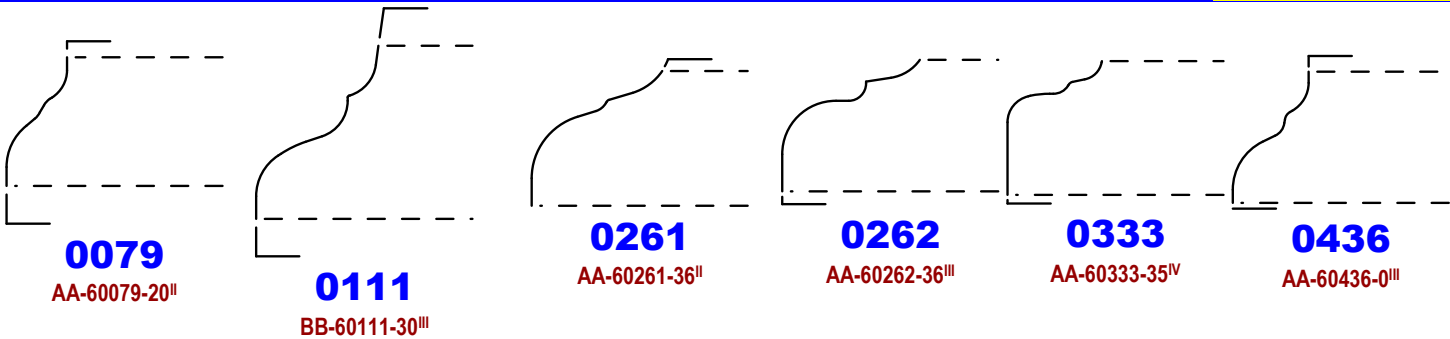

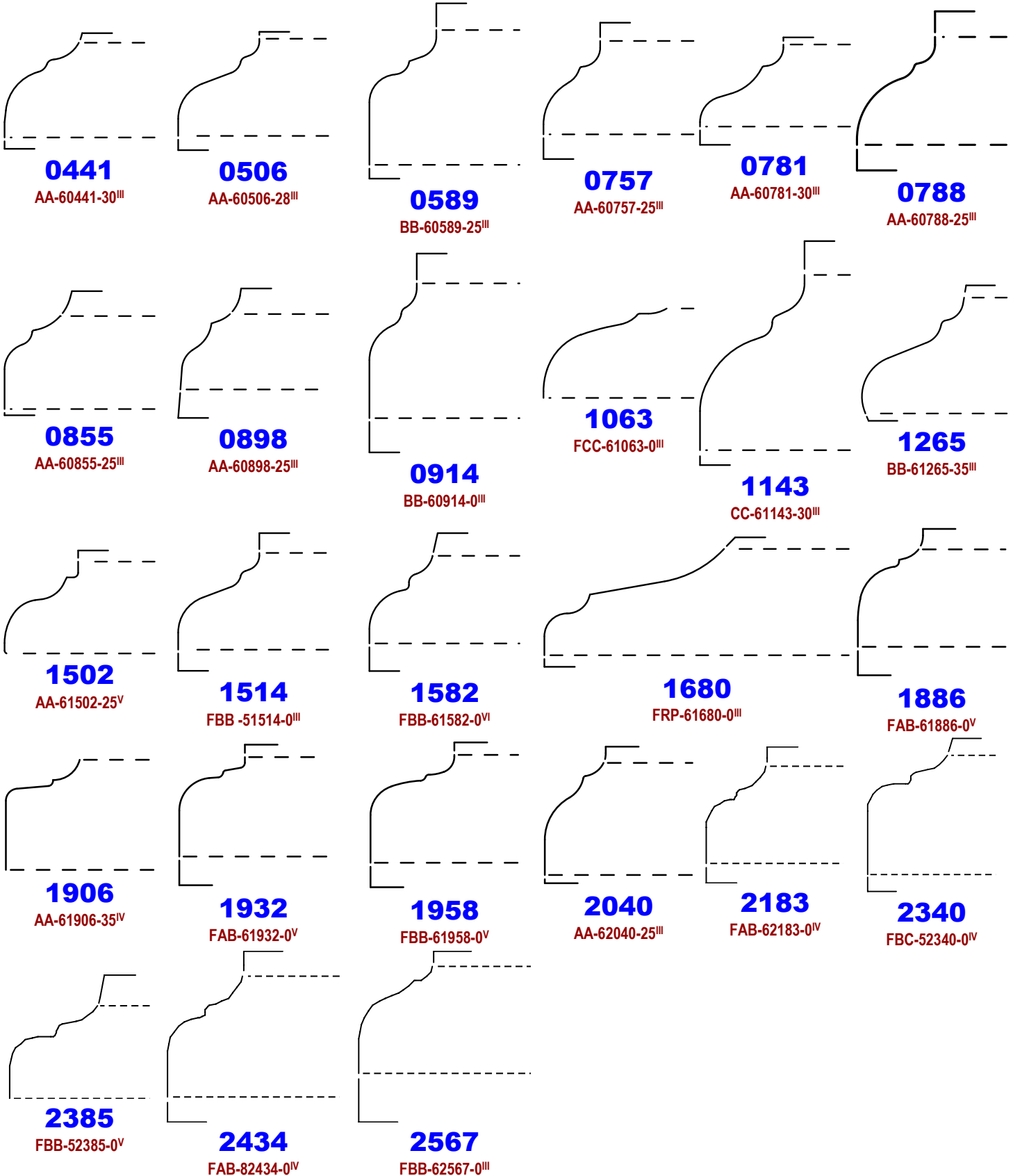

WATERFALL EDGE

4-Curve / 2-Bead Lip

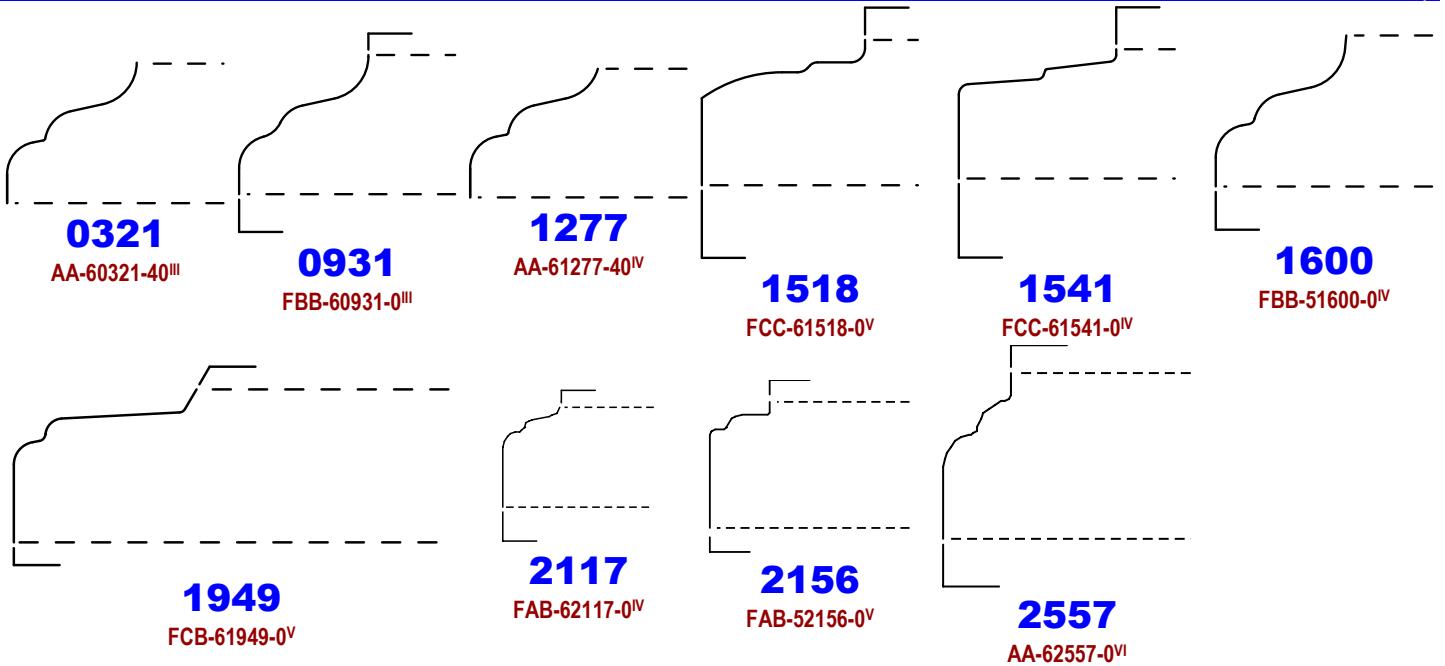

WATERFALL EDGE

4-Curve / 3-Step

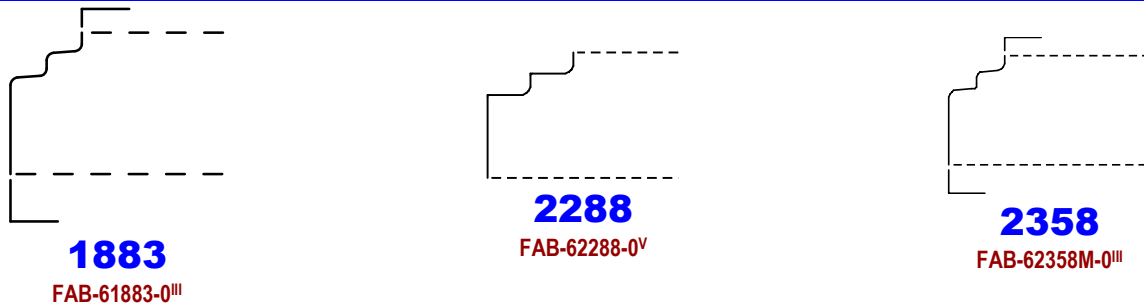

WATERFALL EDGE

5-Curves

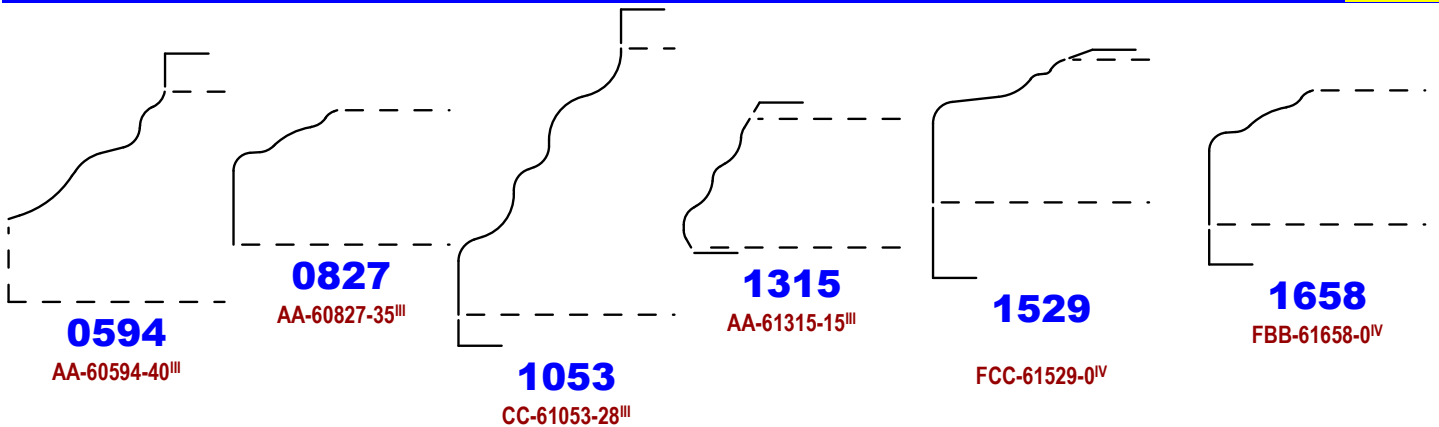

WATERFALL EDGE

5-Curves

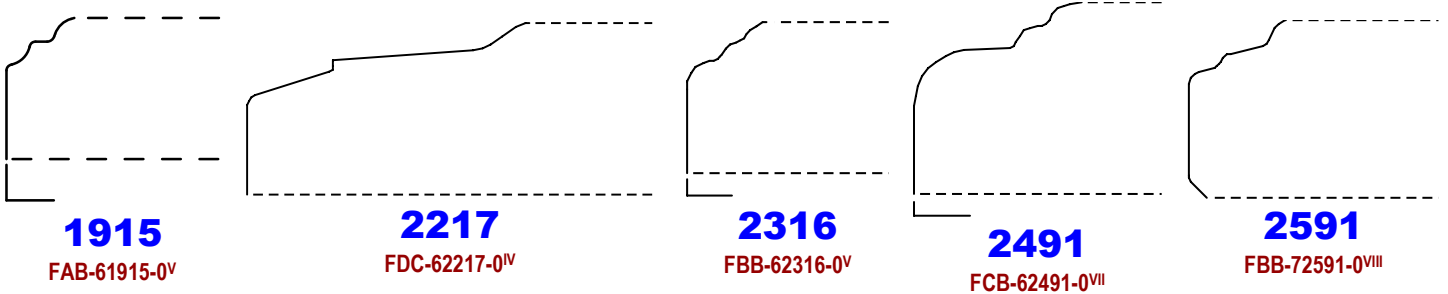

WATERFALL EDGE

6-Curves

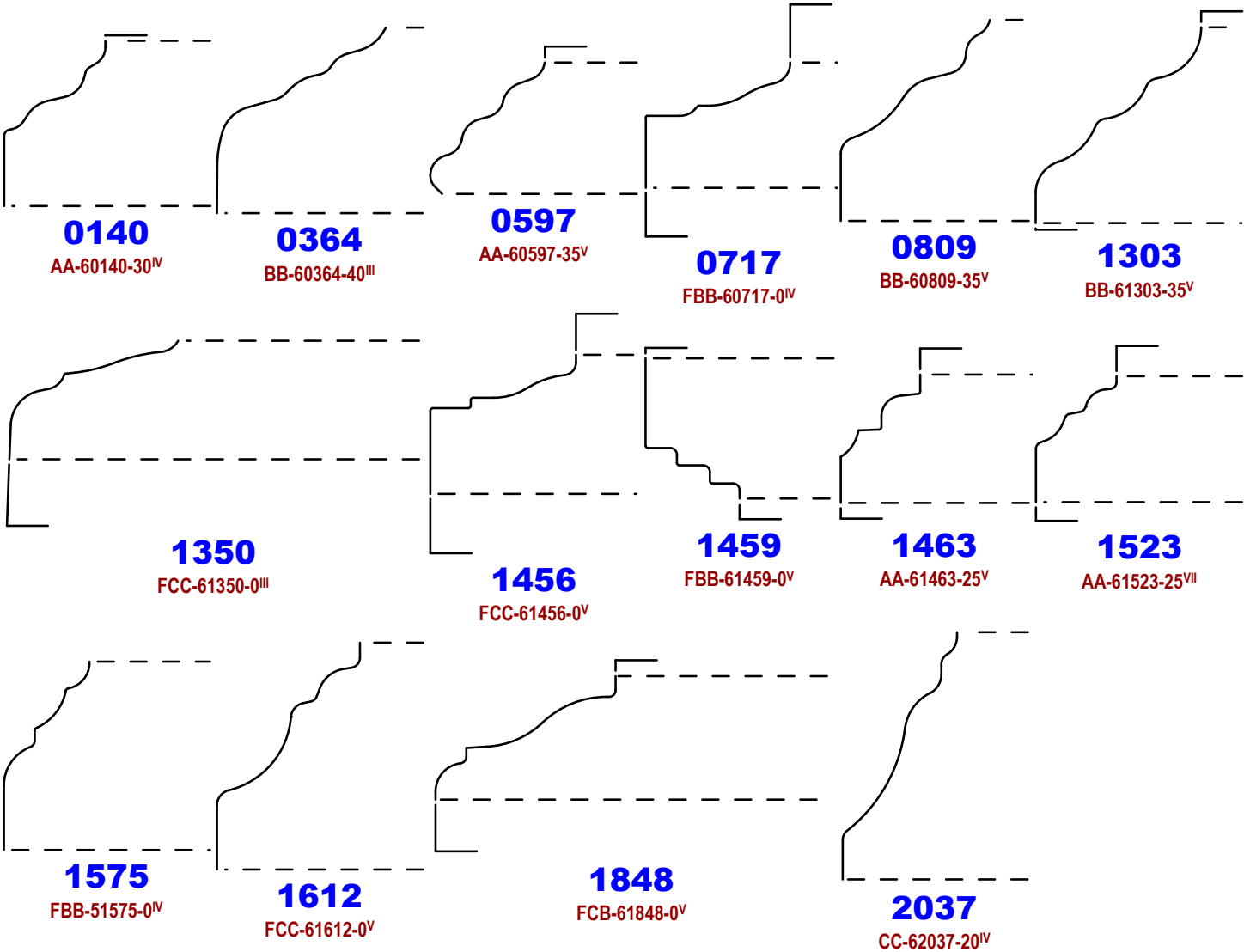

WATERFALL EDGE

6-Curves

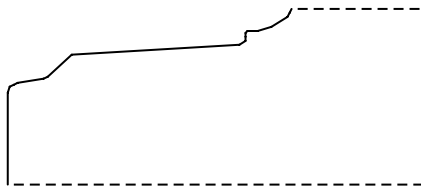

2218
FDC-62218-0^{VI}

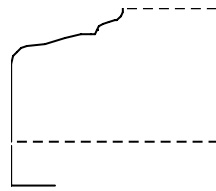

2248
FBB-62248-0^{VI}

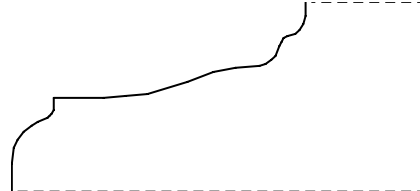

2258
FDC-62258-0^{IV}

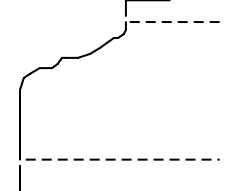

2284
FBB-62284-0^V

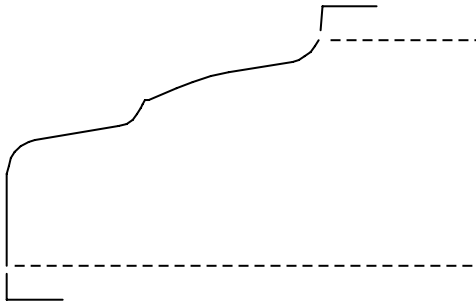

2540
FDC-62540-0^V

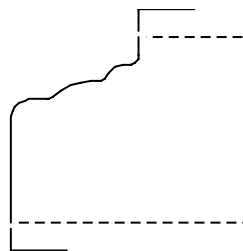

2542
FBB-62542-0^{VI}

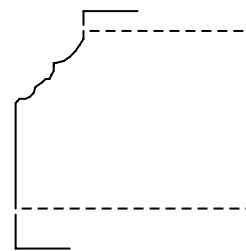

2590
FAB-72590-0^{IX}

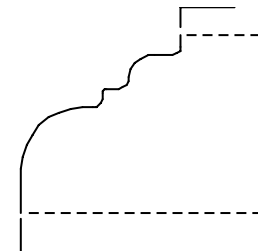

2596
FBB-72596-0^{VII}

WATERFALL EDGE

7 & 8 Curves

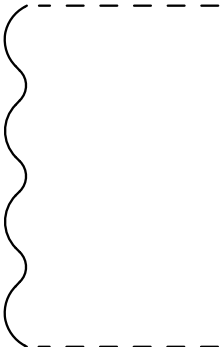

0434
CC-60434-0^{IV}

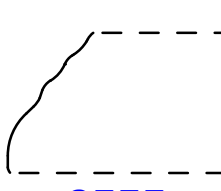

0555
AA-60555-25^{II}

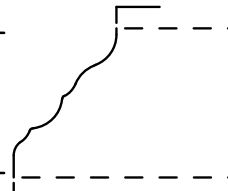

1222
AA-61222-30^V

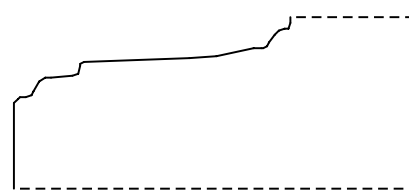

2219
FDC-62219-0^X

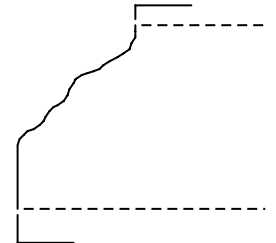

2482
FAB-82482-0^{III}

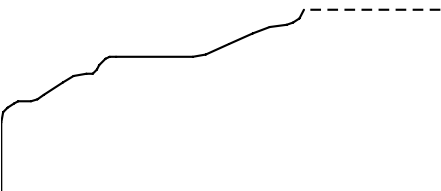

2220
FDC-62220-0^{VII}

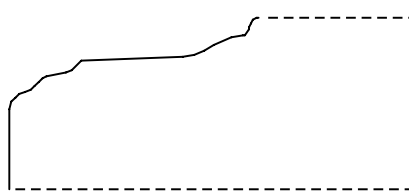

2221
FDC-62221-0^{VII}

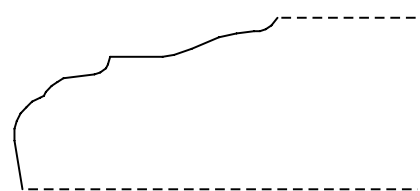

2222
FDC-62222-0^{VI}

WATERFALL EDGE

7 & 8 Curves

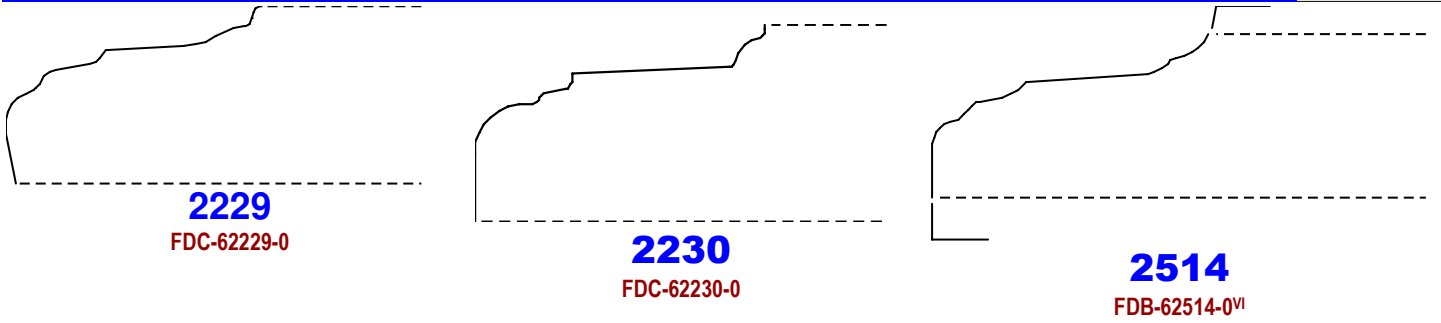

BACKCUT

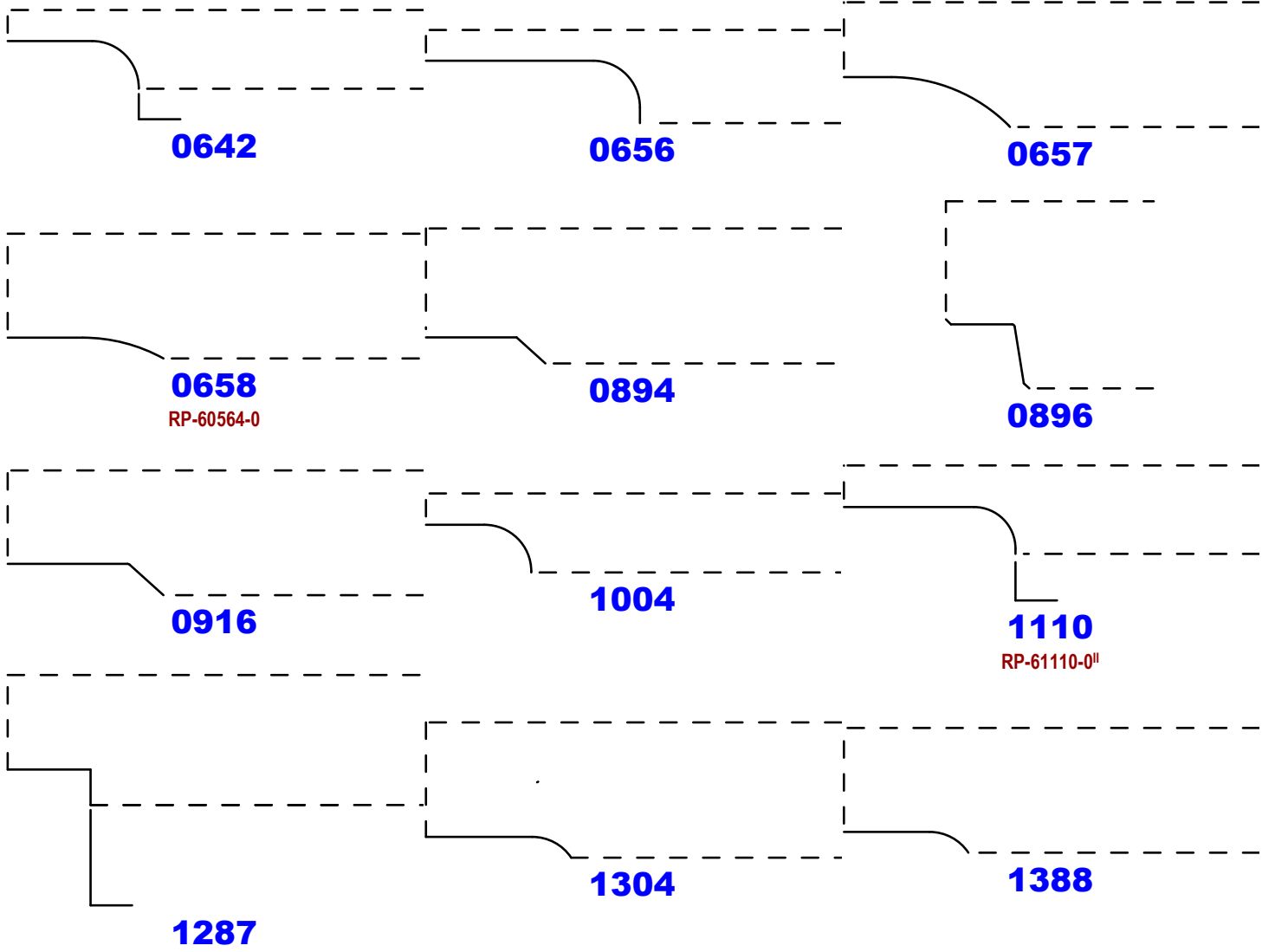

BACKCUT

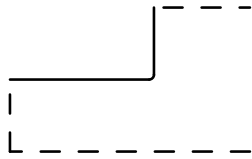

1437

RP-61110-0

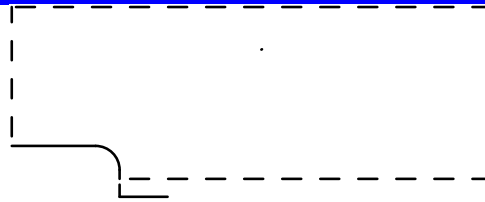

1631

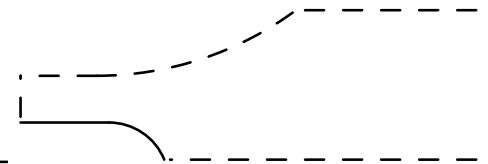

2083



2112

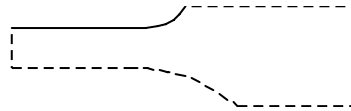

2193

COPE PROFILES

Beveled Edge

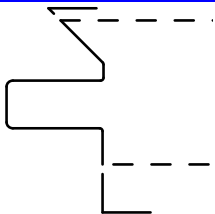

0258

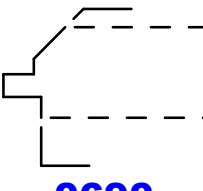

0690

RP -60617-10

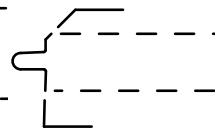

0696

Fits 0697

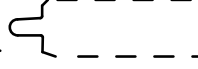

0745

Fits 0746

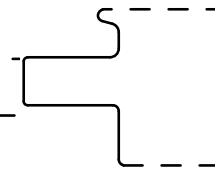

1572

Fits 1571

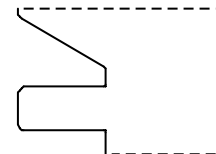

344

Fits 2343

2

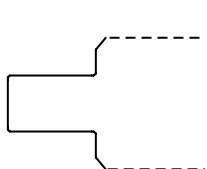

2349

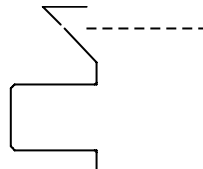

2415

Fits 2414

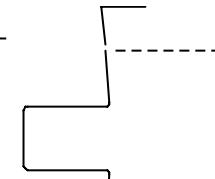

2417

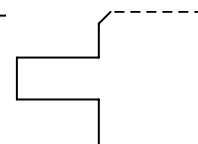

2426

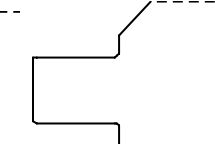

2428

Fits 2414

COPE PROFILES

Corner Round with Rabbet

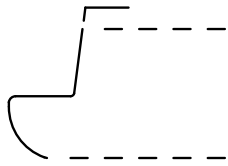

1192

AA-60194-0

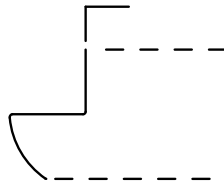

1506

AA-60247-0

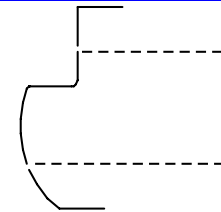

2318

AA-62319-0

COPE PROFILES

2-Curve (Ogee)

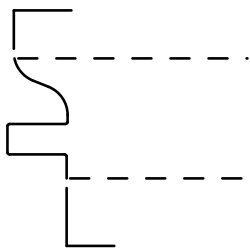

0164

Fits 0163

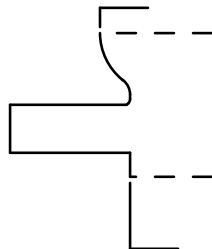

0500

Fits 0499

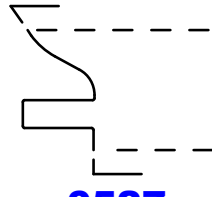

0527

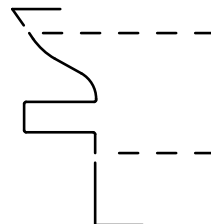

0708

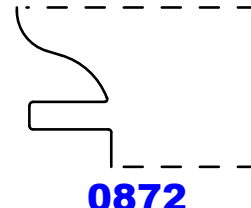

0872

Fits 0871

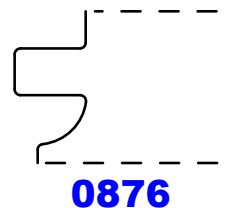

0876

Fits 0877

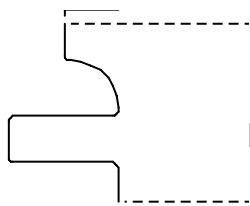

1016

Fits 2079

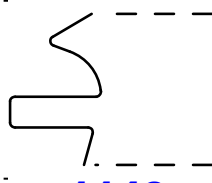

1146

Fits 1145

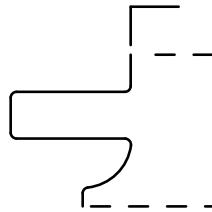

1253

Fits 1254

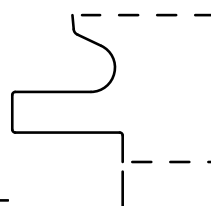

1364

Fits 1363

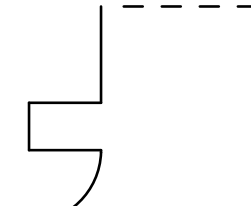

1371

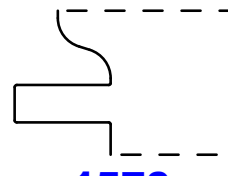

1570

Fits 1569

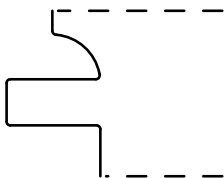

2076

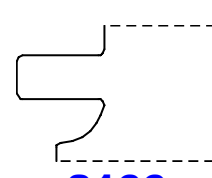

2166

Fits 2126 & 2317

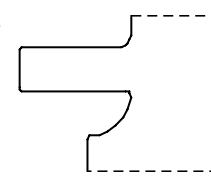

2181

Fits 2178

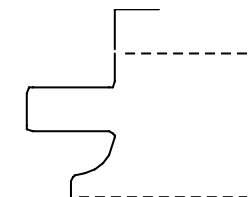

2189

Fits 2191

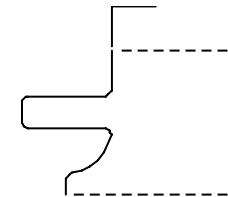

2190

Fits 2192

COPE PROFILES

2-Curve (Ogee)

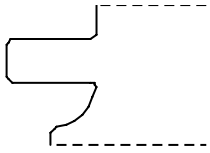

2194

Fits 1980 & 2208

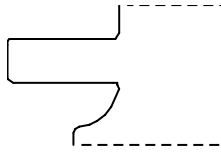

2224

Fits 1254

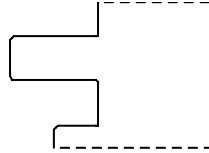

2300

Fits 2295

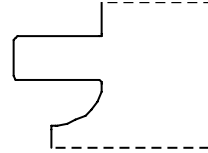

2301

Fits 2296

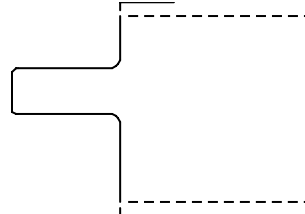

2309

Fits 2489

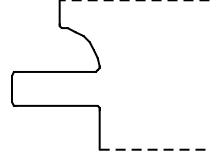

2326

Fits 2325

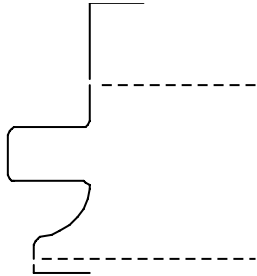

2531

FITS 2500

COPE PROFILES

Square Edge (Shaker)

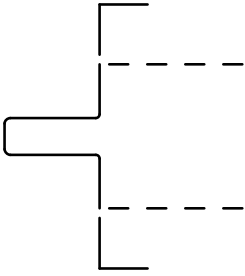

1206

Fits 1205

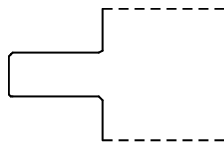

1432

Fits 1360

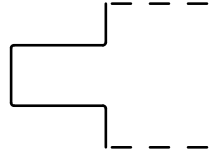

1930

Fits 1929

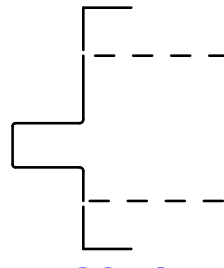

2051

Fits 2050

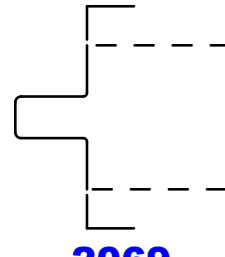

2069

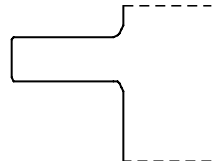

2180

Fits 2177

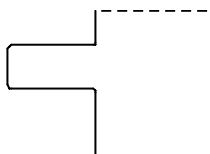

2299

Fits 2294

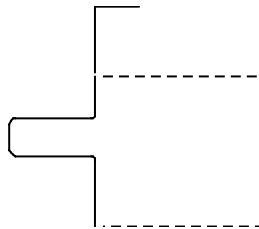

2372

Fits 2188

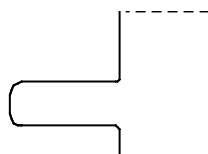

2376

Fits 2213

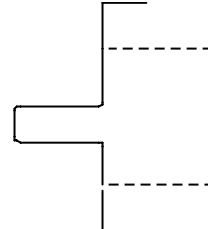

2379

COPE PROFILES

Waterfalls

COPE PROFILES

Waterfalls

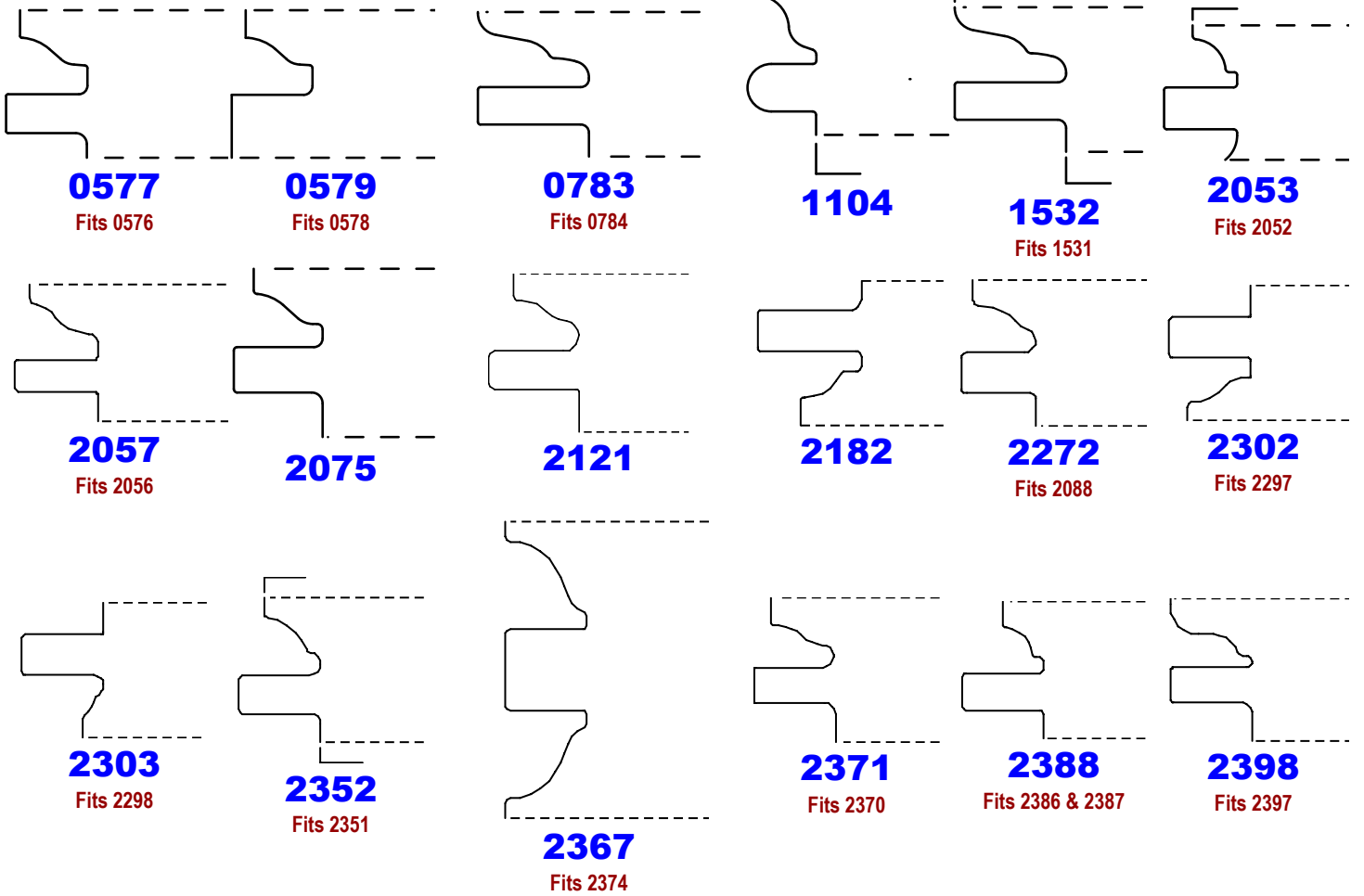

STICK PROFILES

Beveled Edge

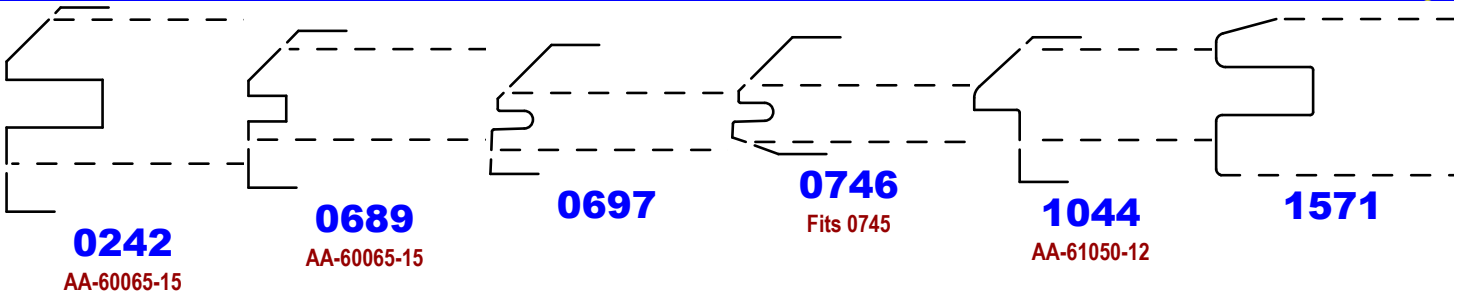

STICK PROFILES

Beveled Edge

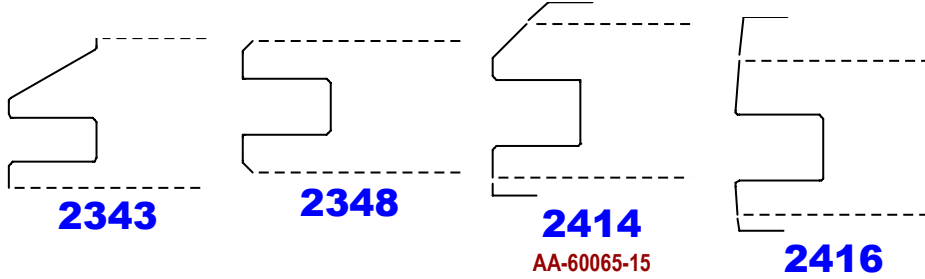

STICK PROFILES

Corner Rounds

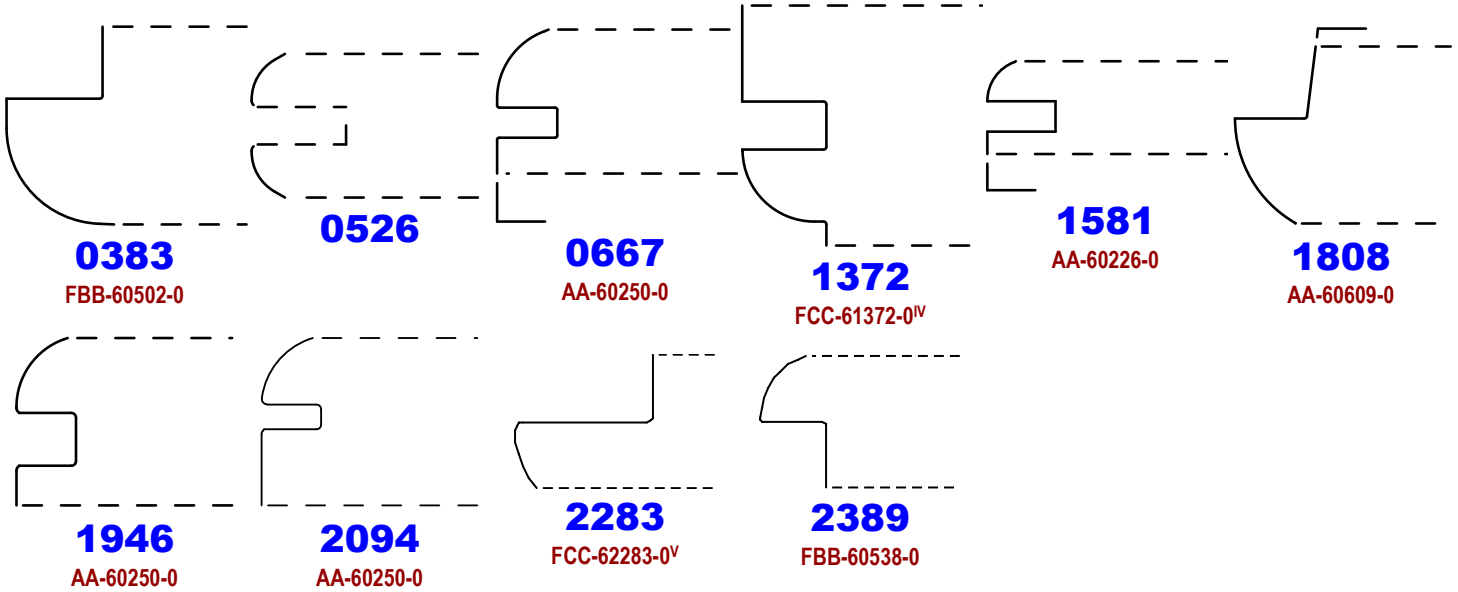

STICK PROFILES

Queue

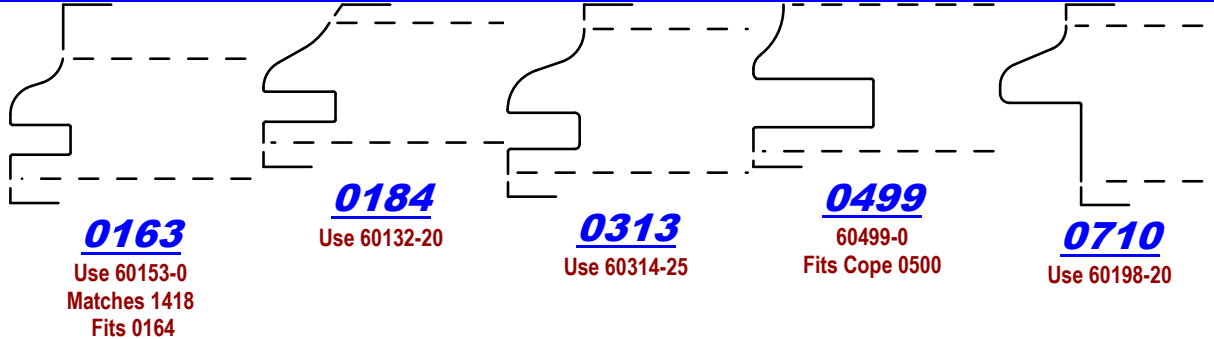

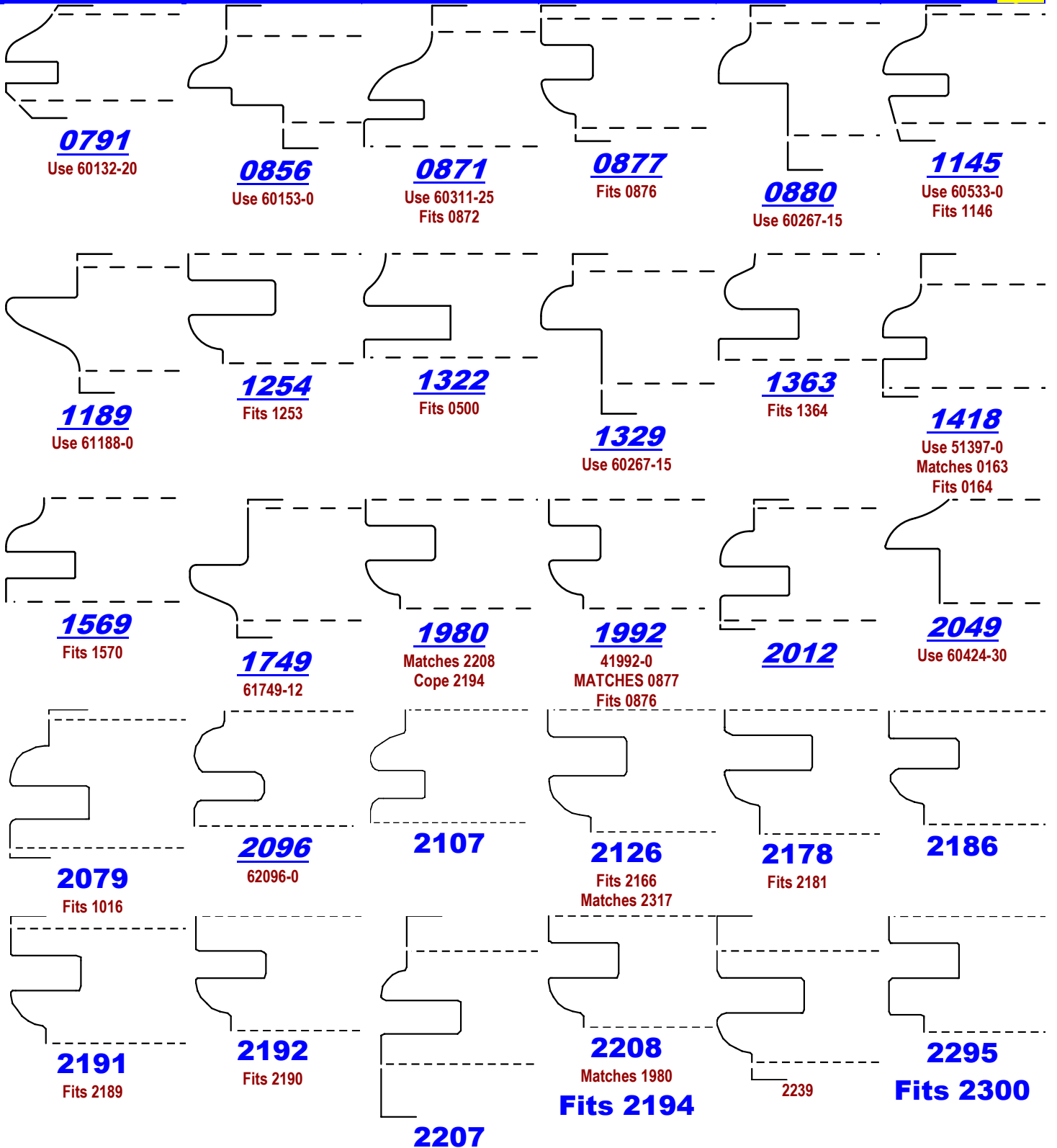

STICK PROFILES

Ogee

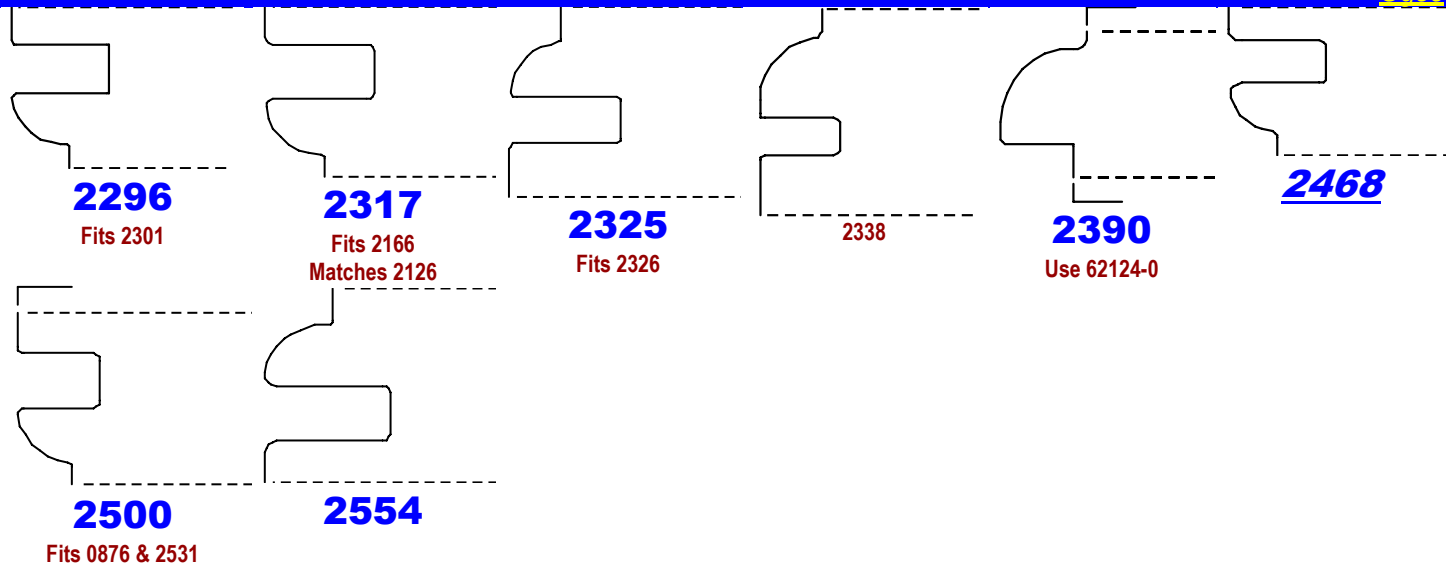

STICK PROFILES

Square Edge (Shaker)

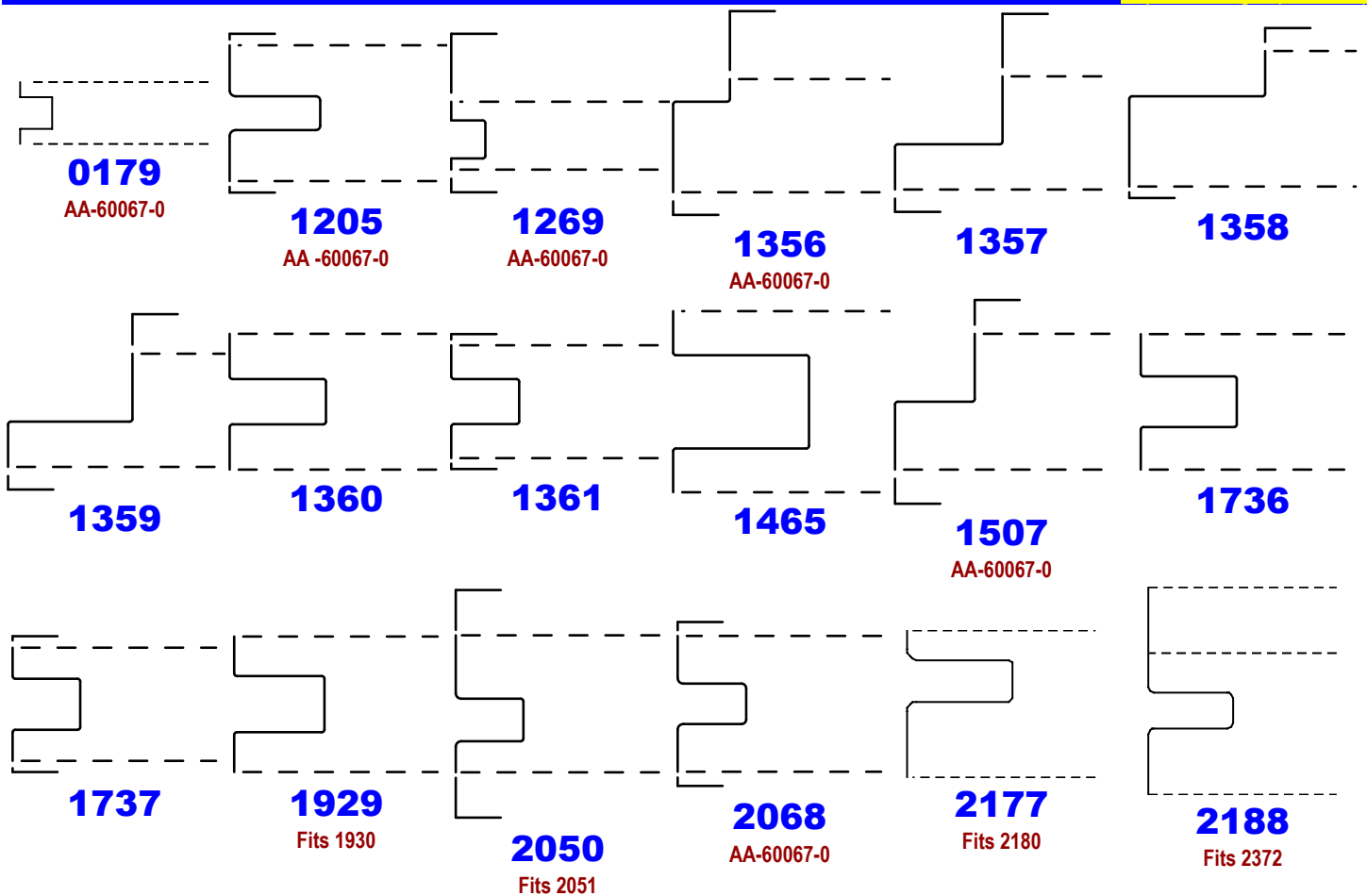

STICK PROFILES

Square Edge (Shaker)

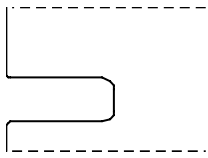

2213

Fits 2376

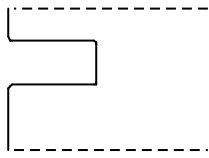

2294

Fits 2299

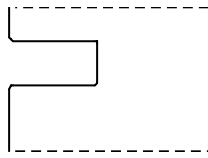

2354

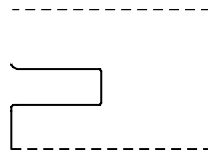

2378

Fits 2379

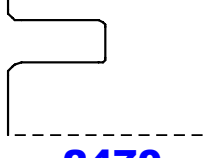

2470

Fits 2372



2489

Fits 2309

STICK PROFILES

Waterfall Style

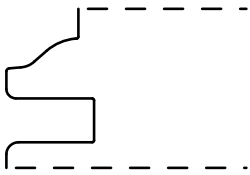

0576

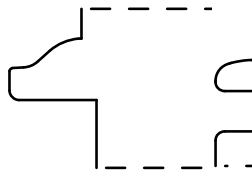

0578

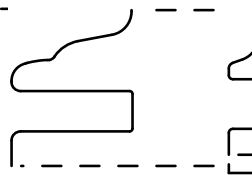

0784

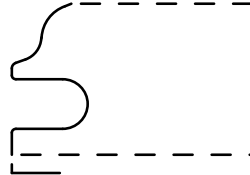

1103

AA-61105-20

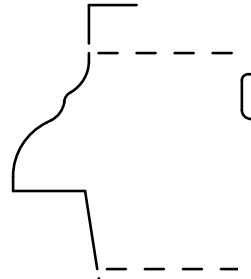

1184

BB-60914-0

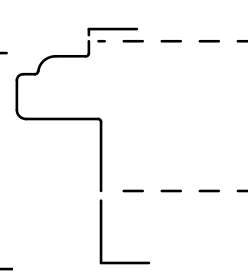

1331

AA-61330-15

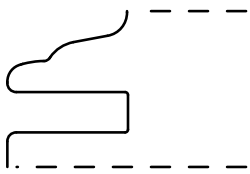

1531

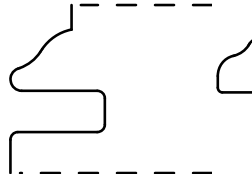

1597

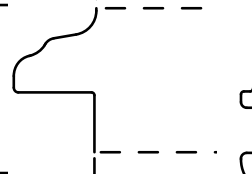

1857

AA-60835-15

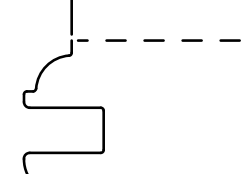

2052

FTA-42052-0V

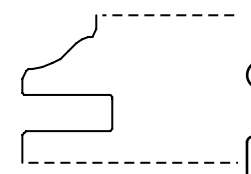

2056

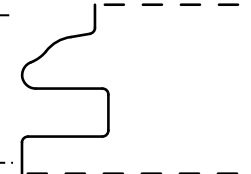

2088

FTA-42088-0V

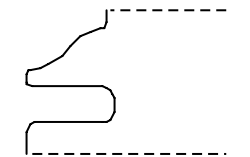

2097

FAB-62097-0V

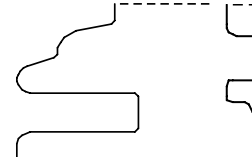

2106

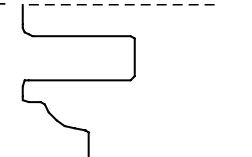

2179

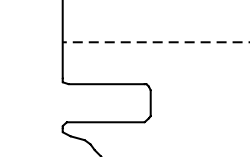

2187

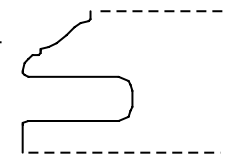

2211

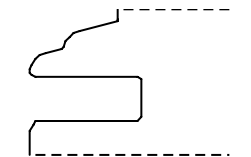

2212

STICK PROFILES

Waterfall Style

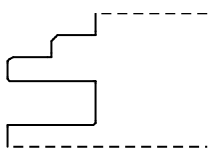

2287

FAB-62288-0

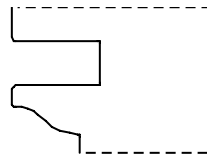

2297

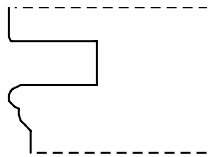

2298

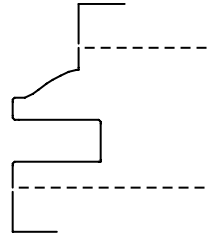

2345

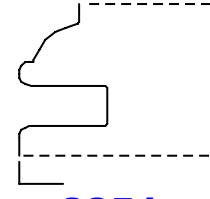

2351

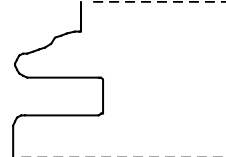

2370

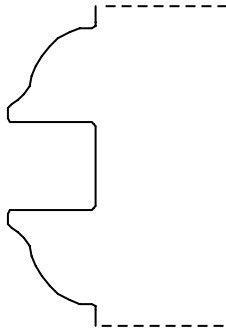

2374

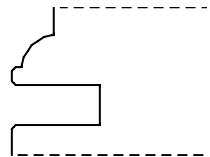

2386

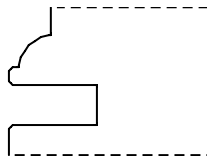

2387

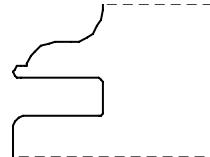

2397

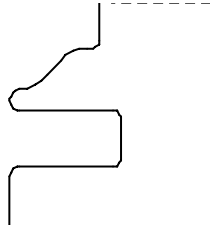

2555

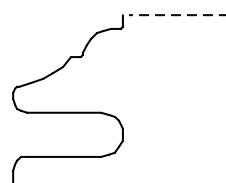

2565

Fits 2566

COMPOUND PROFILES

Requiring 2 Separate Inserts

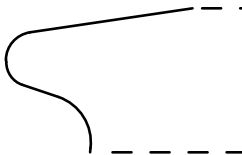

0223

RP-60223A
AA-0223B-0

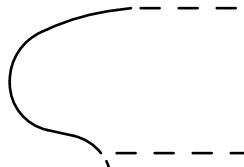

0234

RP-60234A-0
AA-60234B-0

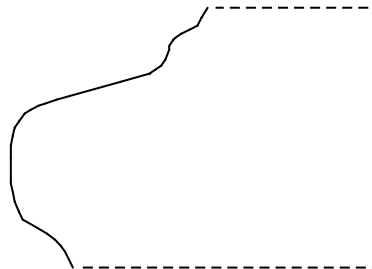

0352

AA-60352A-
BB-60352B-

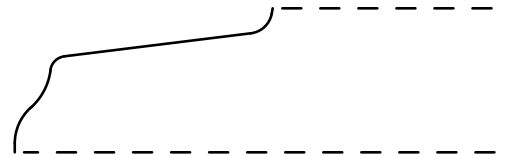

0376

RP-60376A-0
AA-60376B-0

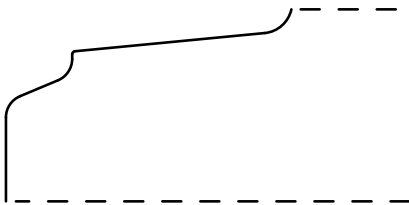

0406

RP-60235-0
AA-60198-0

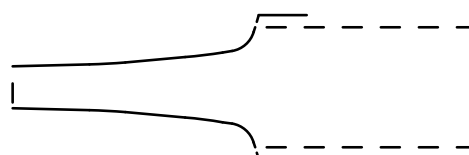

0490

RP-60378-0
RP-60378-0

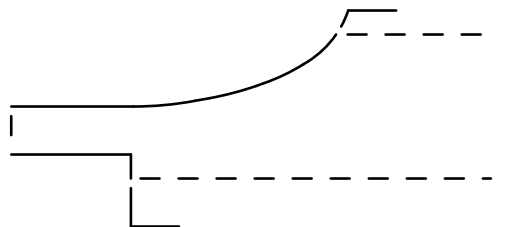

0501

RP-60097-0

COMPOUND PROFILES

Requiring 2 Separate Inserts

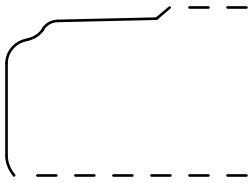

0521
AA-6052-
RP-60400-0

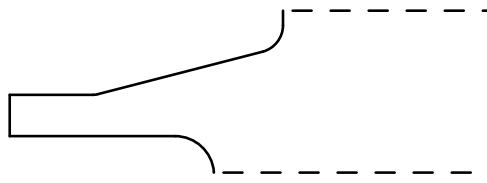

0548
RP-60418-0
RP-60452-0



0580
RP-60327-0
RP-60452-0

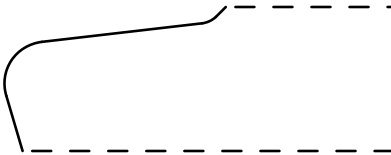

0591
AA-60591A-0
RP-60591B-0

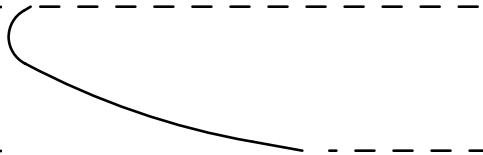

0593
AA-60593A-0
RP-60593B-0

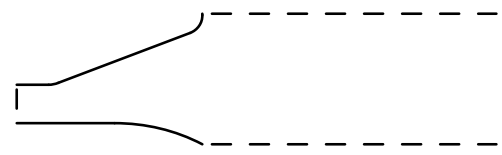

0621
RP-60268-0
RP-60367-0

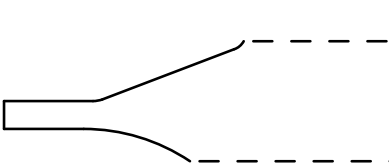

0635
RP-60268-0
RP-60367-0

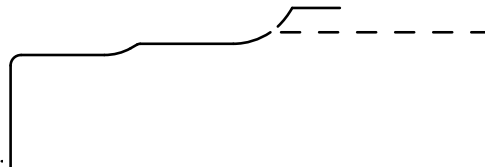

0676
RP-60676A-0
AA-60676B-0

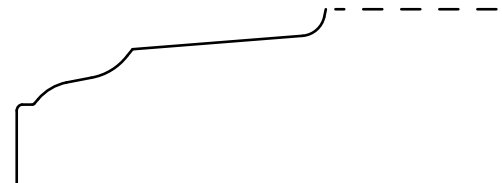

0748
RP-60376-0
AA-60749-0

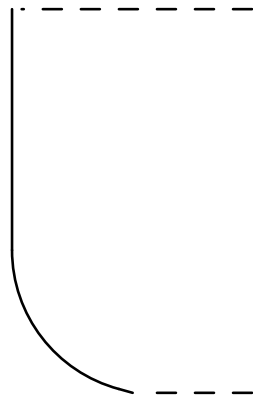

0820
FCC-60774-0
AA-60067-0

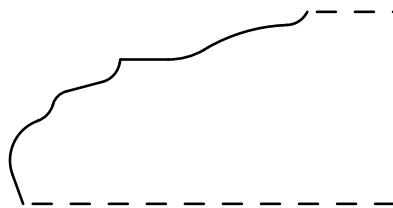

0848
RP-60848-0
AA-60848-30

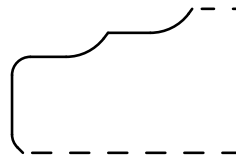

0849
AA-60849A-0
RP-60849B-0

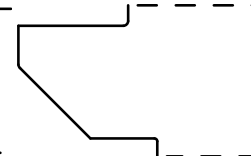

1038
RP-60672-0
FCC-60729-0

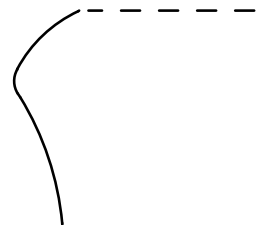

1139
BB-61140-0
FBB-61141-0

COMPOUND PROFILES

Requiring 2 Separate Inserts

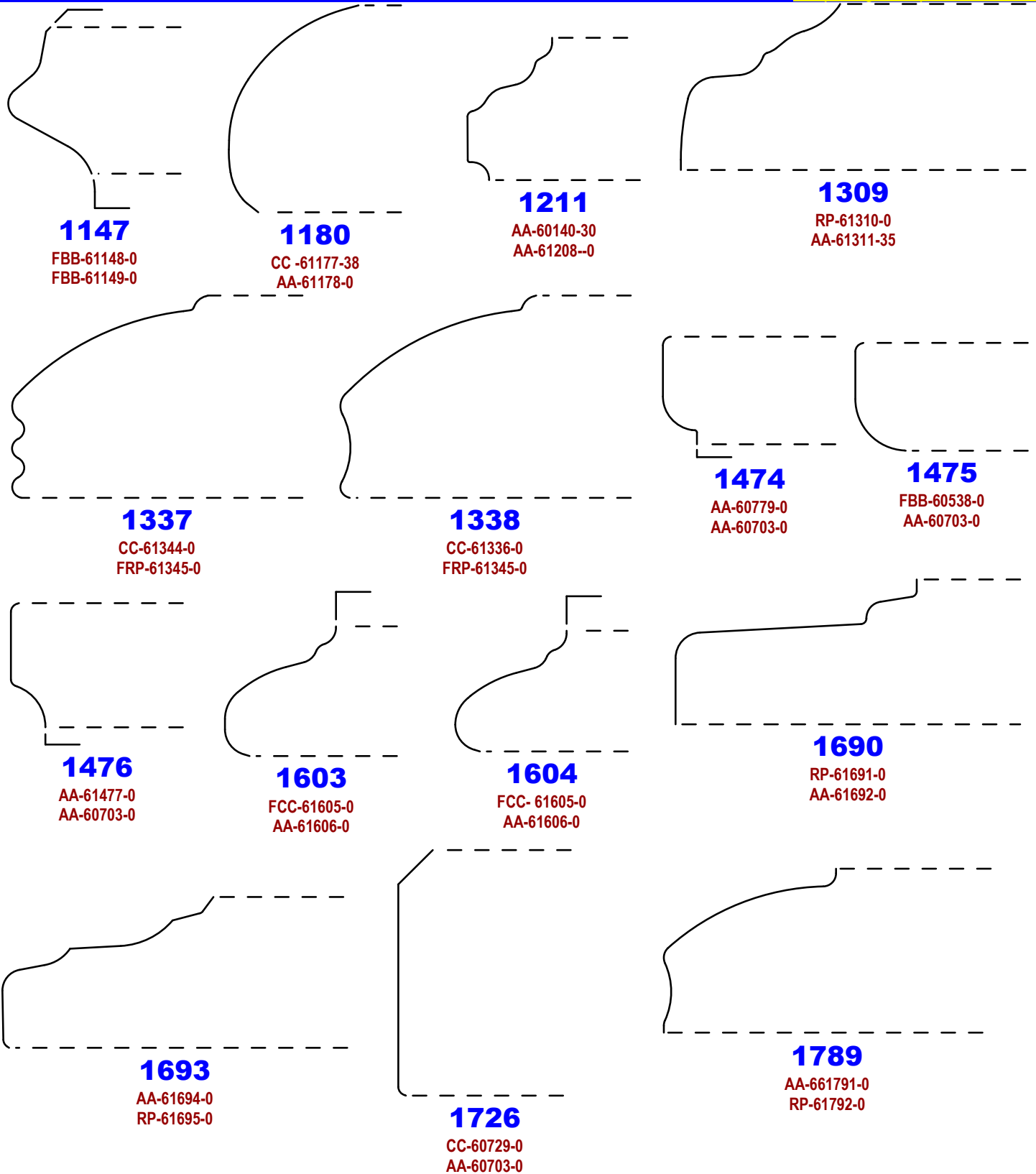

COMPOUND PROFILES

Requiring 2 Separate Inserts

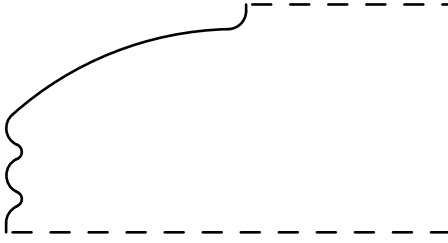

1790

RP-661791-0
AA-61793-0

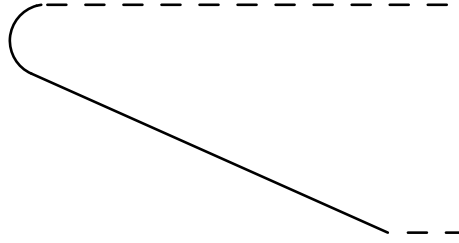

1842

AA-661843-0
FRP-61844-0

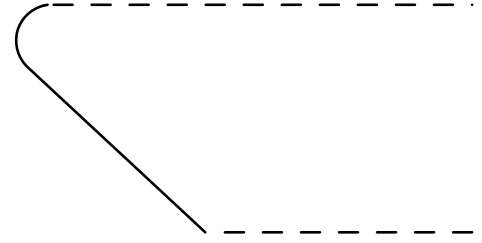

1845

FCC-61846-0
AA-60628-0

INDEX

<i>Pattern</i>	<i>Page</i>	<i>Pattern</i>	<i>Page</i>	<i>Pattern</i>	<i>Page</i>	<i>Pattern</i>	<i>Page</i>	<i>Pattern</i>	<i>Page</i>	<i>Pattern</i>	<i>Page</i>	<i>Pattern</i>	<i>Page</i>		
0052	5	0179	88	0256	30	0325	34	0406	90	0477	9	0552	26	0633	20
0055	33	0181	33	0257	30	0327	50	0407	27	0478	20	0553	30	0635	91
0056	33	0184	86	0258	82	0329	57	0408	3	0479	55	0554	35	0636	75
0057	4	0185	5	0259	45	0332	18	0409	58	0480	55	0555	80	0640	46
0058	5	0186	71	0260	12	0333	76	0410	45	0481	50	0556	75	0641	46
0063	71	0187	71	0261	76	0334	45	0411	45	0482	8	0558	27	0642	81
0064	71	0188	33	0262	76	0335	34	0412	27	0483	31	0559	51	0643	5
0065	5	0190	19	0264	64	0336	68	0413	27	0484	46	0560	26	0644	7
0067	3	0191	33	0265	42	0337	71	0414	34	0485	58	0561	35	0648	17
0072	33	0192	33	0266	8	0339	34	0415	30	0486	35	0563	9	0649	59
0076	8	0194	14	0267	34	0340	7	0416	64	0487	46	0564	46	0650	57
0079	76	0195	19	0268	50	0341	45	0417	20	0488	9	0565	35	0652	70
0080	16	0198	33	0269	34	0342	19	0418	50	0489	9	0566	35	0655	65
0081	75	0199	7	0270	9	0343	19	0419	20	0490	90	0567	12	0656	81
0082	33	0201	71	0271	30	0344	70	0420	68	0491	64	0568	35	0657	81
0083	5	0202	30	0272	8	0345	9	0422	5	0492	75	0569	20	0658	81
0086	7	0205	33	0273	19	0346	16	0423	30	0493	46	0570	26	0659	26
0090	11	0206	27	0274	45	0347	34	0424	34	0494	58	0571	68	0660	17
0092	11	0207	19	0275	8	0348	45	0425	34	0495	12	0572	32	0661	68
0093	33	0208	33	0276	75	0349	45	0426	45	0496	14	0574	35	0663	75
0095	5	0209	71	0277	71	0351	45	0427	45	0497	35	0575	72	0665	30
0097	45	0210	29	0278	71	0352	90	0428	70	0498	9	0576	89	0667	86
0098	27	0211	27	0279	34	0353	16	0430	58	0499	86	0577	85	0668	51
0099	33	0212	16	0280	58	0354	19	0431	34	0500	83	0578	89	0670	20
0105	33	0213	45	0281	58	0355	34	0432	58	0501	90	0579	85	0671	20
0107	11	0214	8	0282	12	0356	34	0433	46	0502	14	0580	91	0672	57
0108	19	0215	9	0283	17	0357	19	0434	80	0503	58	0581	11	0673	65
0109	33	0216	18	0284	27	0358	20	0435	27	0504	58	0582	27	0675	27
0110	11	0217	16	0285	19	0359	20	0436	76	0505	64	0585	72	0676	91
0111	76	0218	33	0287	25	0360	12	0437	71	0506	77	0586	29	0677	17
0114	8	0219	19	0288	70	0361	34	0438	4	0507	50	0587	27	0678	72
0119	19	0220	27	0289	34	0363	27	0439	20	0509	12	0588	59	0684	20
0122	27	0221	27	0290	30	0364	79	0440	72	0510	72	0589	77	0686	8
0126	71	0222	8	0291	34	0365	50	0441	77	0513	9	0590	5	0687	9
0127	33	0223	90	0292	27	0366	42	0443	72	0514	57	0591	91	0688	72
0129	33	0224	8	0294	50	0367	45	0444	58	0515	20	0592	35	0689	85
0132	33	0225	19	0295	27	0368	5	0445	75	0516	46	0593	91	0690	82
0137	30	0226	12	0296	23	0369	71	0446	34	0517	5	0594	78	0691	35
0138	27	0227	71	0297	71	0370	34	0447	30	0519	12	0595	51	0693	35
0140	79	0228	33	0298	50	0371	12	0448	72	0520	64	0597	79	0694	59
0142	33	0229	23	0299	50	0372	12	0449	12	0521	91	0598	9	0696	82
0143	5	0230	19	0300	75	0373	45	0450	70	0522	35	0599	8	0697	85
0146	27	0231	19	0301	71	0374	70	0451	46	0523	12	0600	27	0703	12
0147	19	0232	33	0302	5	0375	34	0452	57	0524	5	0601	14	0706	64
0149	71	0233	16	0303	64	0376	90	0453	34	0526	86	0602	5	0707	32
0150	5	0234	90	0304	34	0377	34	0454	34	0527	83	0603	46	0708	83
0153	33	0235	50	0305	45	0378	50	0455	50	0529	16	0605	20	0710	86
0154	11	0236	33	0306	5	0380	71	0456	58	0530	46	0606	59	0711	20
0156	33	0237	19	0307	34	0381	27	0458	32	0531	27	0607	72	0712	7
0157	71	0238	71	0308	45	0383	86	0459	72	0532	20	0608	59	0713	35
0158	71	0239	9	0309	27	0384	68	0460	46	0533	20	0609	8	0714	12
0160	33	0240	8	0310	27	0385	72	0461	35	0534	58	0610	20	0715	11
0161	42	0241	19	0311	34	0386	12	0462	55	0535	30	0611	8	0717	79
0162	16	0242	85	0312	8	0387	12	0463	20	0536	8	0613	12	0718	27
0163	86	0243	30	0313	86	0388	58	0464	64	0538	14	0615	23	0720	42
0164	83	0244	33	0314	34	0389	58	0465	46	0539	14	0616	51	0721	51
0166	19	0245	8	0315	34	0390	55	0466	20	0540	9	0617	51	0722	35
0167	11	0246	33	0316	19	0391	27	0467	12	0542	3	0619	59	0724	72
0169	30	0247	12	0317	29	0392	20	0468	58	0543	75	0621	91	0725	35
0170	3	0248	71	0318	70	0393	50	0469	72	0544	58	0623	72	0726	72
0171	42	0249	75	0319	71	0397	72	0470	70	0545	42	0624	64	0728	3
0172	42	0250	12	032	19	0398	12	0471	50	0546	26	0625	35	0729	4
0174	5	0251	71	0320	27	0399	5	0472	35	0547	20	0626	17	0730	17
0175	33	0252	33	0321	78	0400	55	0473	58	0548	91	0627	32	0731	14
0176	16	0253	7	0322	44	0401	9	0474	20	0549	64	0629	72	0732	35
0177	25	0254	50	0323	12	0402	34	0475	16	0550	68	0631	35	0733	59
0178	3	0255	12	0324	58	0403	16	0476	72	0551	68	0632	59	0734	72



0735	14	0840	36	0935	51	1107	28	1246	64	1359	88	1467	43	1551	68
0736	35	0841	20	0937	36	1108	51	1247	55	1360	88	1468	21	1552	28
0738	30	0843	12	0939	46	1109	59	1248	47	1361	88	1469	55	1553	38
0739	3	0844	68	0940	46	1110	81	1249	37	1363	87	1470	51	1554	47
0740	18	0845	12	0942	20	1116	59	1250	21	1364	83	1471	32	1556	69
0741	42	0846	72	0944	46	1120	73	1251	37	1365	11	1472	51	1557	19
0743	42	0847	59	0946	47	1121	18	1252	6	1366	65	1474	92	1559	52
0744	30	0848	91	0947	36	1122	29	1253	83	1368	51	1475	92	1560	52
0745	82	0849	91	0948	75	1126	37	1254	87	1369	44	1476	92	1561	69
0746	85	0850	18	0949	59	1130	6	1258	28	1370	60	1477	17	1562	73
0747	59	0851	36	0950	13	1131	37	1260	43	1371	83	1478	13	1564	31
0748	91	0852	36	0952	6	1137	6	1265	77	1372	86	1479	38	1565	76
0749	72	0853	20	0954	6	1138	13	1267	43	1375	15	1480	15	1566	73
0751	12	0855	77	0955	13	1139	91	1268	60	1379	65	1481	15	1567	21
0753	59	0856	87	0962	11	1140	26	1269	88	1380	64	1483	9	1568	55
0756	35	0858	7	0963	17	1141	25	1270	37	1382	31	1484	28	1569	87
0757	77	0860	20	0975	36	1143	77	1271	37	1383	25	1485	21	1570	83
0758	75	0862	5	0979	36	1144	44	1272	43	1387	47	1486	28	1571	85
0759	9	0864	36	0989	72	1145	87	1273	19	1388	81	1487	38	1572	82
0760	9	0865	72	0994	72	1146	83	1277	78	1389	15	1488	38	1573	60
0761	18	0866	68	0995	73	1147	92	1279	67	1390	73	1489	28	1574	13
0763	35	0868	68	0996	13	1148	37	1281	37	1391	38	1490	17	1575	79
0764	20	0870	5	0998	51	1149	37	1283	60	1392	68	1491	26	1576	52
0766	23	0871	87	1002	28	1151	6	1287	81	1393	44	1492	13	1577	60
0767	35	0872	83	1003	70	1157	73	1288	47	1394	7	1493	38	1578	32
0768	35	0873	36	1004	81	1158	21	1289	32	1395	19	1494	13	1579	38
0769	35	0874	17	1005	73	1160	73	1290	68	1396	6	1495	51	1580	73
0770	4	0875	12	1008	73	1169	65	1291	51	1397	38	1496	57	1581	86
0771	42	0876	83	1009	20	1170	13	1294	67	1400	73	1497	47	1582	77
0772	42	0877	87	1010	73	1172	37	1295	64	1401	13	1498	57	1583	21
0774	14	0878	13	1013	73	1174	47	1297	18	1402	15	1499	52	1584	60
0776	42	0879	17	1016	83	1175	59	1300	51	1404	73	1500	52	1586	28
0779	35	0880	87	1026	59	1176	13	1301	23	1405	19	1501	60	1588	60
0780	23	0881	5	1029	55	1177	13	1303	79	1407	29	1502	77	1589	38
0781	77	0883	8	1030	20	1178	15	1304	81	1408	28	1504	68	1590	38
0782	46	0884	9	1031	55	1179	13	1305	65	1410	47	1505	21	1592	52
0783	85	0885	17	1032	73	1180	92	1306	10	1411	4	1506	83	1593	64
0784	89	0886	11	1033	13	1184	89	1307	10	1414	3	1507	88	1594	67
0785	42	0888	51	1034	36	1186	37	1308	37	1418	87	1508	38	1595	26
0786	9	0890	28	1035	73	1187	47	1309	92	1421	13	1509	68	1596	60
0787	36	0892	29	1036	23	1188	37	1310	73	1422	13	1510	68	1597	89
0788	77	0893	32	1037	73	1189	87	1311	37	1423	17	1513	60	1598	6
0789	51	0894	81	1038	91	1191	37	1312	37	1425	21	1514	77	1599	15
0790	12	0896	81	1041	42	1192	83	1314	9	1427	38	1515	6	1600	78
0791	87	0898	77	1043	36	1194	30	1315	78	1428	38	1517	38	1601	60
0792	72	0900	18	1044	85	1195	30	1316	73	1430	73	1518	78	1602	52
0793	26	0901	14	1046	57	1196	29	1317	23	1431	73	1519	44	1603	92
0794	4	0902	65	1048	37	1197	7	1318	10	1432	84	1522	38	1604	92
0796	27	0903	13	105	37	1199	75	1319	37	1433	70	1523	79	1605	74
0799	36	0904	10	1050	6	1201	37	1320	73	1434	60	1524	38	1606	15
0802	36	0905	29	1053	78	1204	9	1326	70	1435	47	1525	3	1607	60
0803	32	0907	75	1054	51	1205	88	1327	68	1437	82	1526	15	1608	47
0804	32	0911	25	1056	37	1206	84	1328	68	1439	23	1527	4	1609	47
0805	12	0914	77	1057	73	1208	37	1329	87	1440	73	1528	65	1610	21
0806	51	0916	81	1058	17	1210	37	1330	75	1442	51	1529	78	1611	74
0808	36	0917	36	1059	21	1211	92	1331	89	1443	6	1530	65	1612	79
0809	79	0918	72	1061	6	1212	21	1333	51	1444	19	1531	89	1613	11
0811	30	0919	6	1063	77	1216	37	1336	68	1446	60	1532	85	1614	52
0814	27	0920	36	1064	8	1217	68	1337	92	1447	21	1533	32	1616	21
0816	20	0921	46	1065	21	1219	59	1338	92	1451	73	1534	52	1617	60
0817	30	0922	46	1067	37	1222	80	1344	10	1452	75	1535	60	1618	7
0818	72	0923	46	1069	37	1223	73	1345	70	1453	73	1537	71	1619	74
0820	91	0924	13	1072	10	1224	42	1347	65	1454	65	1539	60	1620	6
0821	72	0925	36	1078	37	1226	42	1348	55	1456	79	1540	55	1621	17
0827	78	0926	6	1080	28	1228	43	1350	79	1457	70	1541	78	1622	38
0828	23	0927	36	1081	37	1230	43	1351	37	1458	75	1542	65	1623	38
0830	5	0928	59	1097	7	1232	43	1352	70	1459	79	1543	75	1624	71
0831	23	0929	36	1100	70	1234	23	1353	60	1460	21	1544	21	1625	52
0833	23	0930	46	1103	89	1236	19	1354	73	1461	10	1545	21	1626	29
0835	72	0931	78	1104	85	1237	15	1356	88	1462	68	1546	23	1627	74
0837	36	0932	17	1105	73	1241	37	1357	88	1463	79	1549	68	1628	24
0838	25	0934	36	1106	23	1244	55	1358	88	1465	88	1550	68	1629	65



Turbosand Abrasive Sales
 2350 Barney Street, Anderson, CA 96002 USA
 Phone: (530) 378-6891 Toll Free
 1-877-348-8726

1630	47	1705	39	1791	57	1872	53	1960	28	2056	89	2139	56	2225	24
1631	82	1706	74	1792	69	1873	13	1961	22	2057	85	2140	17	2227	76
1632	31	1707	23	1793	69	1874	4	1962	3	2058	40	2141	22	2228	31
1633	76	1708	21	1794	39	1875	22	1963	40	2064	76	2142	14	2229	81
1634	31	1709	39	1795	67	1877	74	1964	22	2065	49	2143	69	2230	81
1635	30	1710	39	1796	74	1878	40	1965	74	2066	31	2145	76	2231	54
1636	30	1711	69	1797	30	1879	74	1966	66	2067	31	2146	24	2233	56
1637	71	1712	57	1798	7	1880	22	1967	40	2068	88	2148	24	2234	62
1638	47	1713	29	1802	18	1881	74	1968	66	2069	84	2155	40	2235	24
1639	74	1714	39	1803	30	1882	40	1969	74	2071	28	2156	78	2236	23
1640	52	1715	39	1804	74	1883	78	1970	55	2072	70	2157	40	2237	11
1641	52	1716	29	1805	10	1884	40	1971	64	2073	15	2158	76	2238	18
1642	30	1717	44	1806	23	1886	77	1972	74	2074	26	2159	74	2239	87
1643	24	1718	52	1807	39	1887	76	1973	10	2075	85	2160	40	2240	44
1644	26	1719	30	1808	86	1888	13	1975	53	2076	83	2161	6	2242	22
1645	38	1720	30	1809	39	1889	40	1976	53	2078	76	2162	54	2244	62
1647	21	1721	32	1810	21	1890	18	1977	22	2079	87	2163	62	2246	41
1650	10	1722	39	1811	48	1891	53	1978	48	2080	24	2164	49	2248	80
1651	9	1723	56	1812	61	1892	24	1979	25	2081	67	2165	44	2250	74
1652	52	1724	56	1813	56	1893	22	1980	87	2082	49	2166	83	2252	74
1653	30	1725	52	1814	53	1894	25	1981	28	2083	82	2167	40	2253	11
1654	38	1726	92	1815	61	1895	26	1983	22	2085	62	2168	49	2254	24
1655	47	1727	39	1816	74	1896	29	1984	6	2086	23	2169	22	2255	31
1656	64	1728	48	1817	44	1897	28	1985	19	2087	43	2170	49	2256	70
1657	13	1729	61	1818	65	1898	11	1986	17	2088	89	2171	22	2257	15
1658	78	1730	52	1819	61	1899	31	1988	48	2089	11	2172	74	2258	80
1659	57	1731	57	1821	30	1900	22	1989	76	2090	24	2173	31	2260	49
1660	47	1732	69	1822	53	1902	61	1992	87	2091	6	2174	24	2261	54
1661	47	1733	6	1823	48	1903	10	1993	22	2092	6	2175	24	2262	49
1662	61	1734	13	1824	61	1904	69	1996	56	2093	22	2177	88	2263	56
1663	52	1735	56	1825	13	1905	40	1997	44	2094	86	2178	87	2268	76
1664	57	1736	88	1826	39	1906	77	1998	61	2095	62	2179	89	2271	3
1665	47	1737	88	1827	24	1907	61	1999	74	2096	87	2180	84	2272	85
1666	61	1738	39	1828	21	1910	69	2000	40	2097	89	2181	83	2276	26
1667	48	1739	29	1830	65	1911	69	2001	76	2098	24	2182	85	2277	26
1668	38	1740	53	1831	48	1913	69	2003	26	2099	62	2183	77	2279	18
1669	70	1741	48	1832	66	1914	69	2004	40	2100	62	2184	66	2283	86
1670	26	1742	56	1833	66	1915	79	2005	40	2101	49	2185	40	2284	80
1671	38	1744	39	1834	48	1916	53	2006	40	2102	66	2186	87	2285	25
1672	21	1745	39	1835	48	1917	31	2007	53	2103	44	2187	89	2287	90
1673	21	1746	10	1836	53	1918	28	2008	61	2104	43	2188	88	2288	78
1674	74	1747	10	1837	19	1919	40	2009	40	2105	6	2189	83	2290	62
1675	67	1748	7	1838	61	1920	53	2010	14	2106	89	2190	83	2291	24
1676	25	1749	87	1839	48	1921	44	2012	87	2107	87	2191	87	2292	23
1677	21	1751	18	1840	39	1923	53	2015	74	2108	62	2192	87	2294	89
1678	55	1752	15	1841	40	1924	43	2016	54	2109	14	2193	82	2295	87
1679	38	1753	53	1842	93	1926	22	2017	54	2111	28	2194	84	2296	88
1680	77	1755	74	1843	9	1927	22	2018	56	2112	82	2195	22	2297	90
1681	38	1756	10	1844	4	1928	67	2020	66	2113	62	2197	7	2298	90
1682	28	1757	39	1845	93	1929	88	2021	44	2114	62	2198	10	2299	84
1683	38	1758	21	1846	4	1930	84	2022	74	2115	14	2199	11	2300	84
1684	61	1768	65	1847	66	1931	53	2030	54	2116	26	2200	31	2301	84
1685	48	1769	61	1848	79	1932	77	2032	6	2117	78	2201	32	2302	85
1686	39	1770	23	1850	13	1933	66	2033	22	2118	56	2202	32	2303	85
1687	39	1771	76	1851	21	1934	61	2034	57	2119	54	2203	32	2305	62
1688	8	1772	64	1852	66	1935	56	2036	22	2120	49	2204	32	2307	56
1689	52	1773	61	1853	31	1938	76	2037	79	2121	85	2205	24	2310	49
1690	92	1774	32	1854	21	1940	48	2038	28	2122	22	2206	17	2311	28
1691	55	1775	53	1857	89	1942	11	2039	48	2124	40	2207	87	2312	62
1692	15	1776	48	1859	15	1943	24	2040	77	2125	74	2208	87	2313	22
1693	92	1777	65	1860	40	1944	53	2041	49	2126	87	2210	74	2314	41
1694	55	1779	21	1861	13	1945	61	2042	40	2127	31	2211	89	2315	69
1695	21	1780	21	1862	18	1946	86	2043	49	2128	26	2212	89	2316	79
1696	61	1781	15	1863	15	1949	78	2046	56	2129	23	2213	89	2317	88
1697	65	1782	56	1864	15	1950	53	2048	28	2130	24	2214	66	2318	83
1698	30	1783	67	1865	15	1951	53	2049	87	2131	24	2217	79	2319	7
1699	39	1785	69	1866	40	1954	22	2050	88	2132	14	2218	80	2320	63
1700	13	1786	69	1867	40	1955	11	2051	84	2133	15	2219	80	2321	22
1701	48	1787	69	1868	13	1956	32	2052	89	2134	14	2220	80	2322	41
1702	48	1788	69	1869	66	1957	31	2053	85	2135	26	2221	80	2323	24
1703	26	1789	92	1870	44	1958	77	2054	43	2136	67	2222	80	2324	28
1704	39	1790	93	1871	74	1959	66	2055	40	2137	54	2224	84	2325	88



<u>2326</u>	<u>84</u>	<u>2416</u>	<u>86</u>	<u>2515</u>	<u>22</u>
<u>2330</u>	<u>41</u>	<u>2417</u>	<u>82</u>	<u>2516</u>	<u>41</u>
<u>2333</u>	<u>74</u>	<u>2418</u>	<u>28</u>	<u>2517</u>	<u>41</u>
<u>2335</u>	<u>63</u>	<u>2419</u>	<u>70</u>	<u>2518</u>	<u>41</u>
<u>2336</u>	<u>74</u>	<u>2420</u>	<u>28</u>	<u>2521</u>	<u>41</u>
<u>2338</u>	<u>88</u>	<u>2421</u>	<u>63</u>	<u>2522</u>	<u>69</u>
<u>2339</u>	<u>4</u>	<u>2422</u>	<u>57</u>	<u>2523</u>	<u>7</u>
<u>2340</u>	<u>77</u>	<u>2423</u>	<u>66</u>	<u>2526</u>	<u>54</u>
<u>2341</u>	<u>23</u>	<u>2424</u>	<u>54</u>	<u>2528</u>	<u>18</u>
<u>2342</u>	<u>22</u>	<u>2426</u>	<u>82</u>	<u>2529</u>	<u>69</u>
<u>2343</u>	<u>86</u>	<u>2427</u>	<u>63</u>	<u>2530</u>	<u>29</u>
<u>2344</u>	<u>82</u>	<u>2428</u>	<u>82</u>	<u>2531</u>	<u>84</u>
<u>2345</u>	<u>90</u>	<u>2429</u>	<u>41</u>	<u>2532</u>	<u>41</u>
<u>2347</u>	<u>24</u>	<u>2434</u>	<u>77</u>	<u>2533</u>	<u>76</u>
<u>2348</u>	<u>86</u>	<u>2438</u>	<u>75</u>	<u>2534</u>	<u>67</u>
<u>2349</u>	<u>82</u>	<u>2440</u>	<u>18</u>	<u>2535</u>	<u>54</u>
<u>2351</u>	<u>90</u>	<u>2441</u>	<u>66</u>	<u>2536</u>	<u>63</u>
<u>2352</u>	<u>85</u>	<u>2442</u>	<u>63</u>	<u>2537</u>	<u>49</u>
<u>2354</u>	<u>89</u>	<u>2444</u>	<u>18</u>	<u>2538</u>	<u>67</u>
<u>2355</u>	<u>63</u>	<u>2445</u>	<u>22</u>	<u>2539</u>	<u>54</u>
<u>2356</u>	<u>7</u>	<u>2446</u>	<u>41</u>	<u>2540</u>	<u>80</u>
<u>2357</u>	<u>76</u>	<u>2447</u>	<u>24</u>	<u>2541</u>	<u>63</u>
<u>2358</u>	<u>78</u>	<u>2448</u>	<u>75</u>	<u>2542</u>	<u>80</u>
<u>2359</u>	<u>22</u>	<u>2449</u>	<u>70</u>	<u>2544</u>	<u>49, 63</u>
<u>2360</u>	<u>10</u>	<u>2450</u>	<u>49</u>	<u>2545</u>	<u>41</u>
<u>2361</u>	<u>75</u>	<u>2451</u>	<u>31</u>	²⁵⁴⁶	<u>7</u>
<u>2362</u>	<u>41</u>	<u>2454</u>	<u>14</u>	<u>2547</u>	<u>10</u>
<u>2363</u>	<u>3</u>	<u>2455</u>	<u>10</u>	<u>2548</u>	<u>64</u>
<u>2364</u>	<u>69</u>	<u>2456</u>	<u>11</u>	<u>2549</u>	<u>49</u>
<u>2365</u>	<u>66</u>	<u>2457</u>	<u>10</u>	<u>2550</u>	<u>31</u>
<u>2366</u>	<u>63</u>	<u>2458</u>	<u>32</u>	<u>2553</u>	<u>32</u>
<u>2367</u>	<u>85</u>	<u>2459</u>	<u>22</u>	<u>2554</u>	<u>88</u>
<u>2368</u>	<u>44</u>	<u>2462</u>	<u>54</u>	<u>2555</u>	<u>90</u>
<u>2370</u>	<u>90</u>	<u>2463</u>	<u>41</u>	<u>2557</u>	<u>78</u>
<u>2371</u>	<u>85</u>	<u>2467</u>	<u>56</u>	<u>2559</u>	<u>14</u>
<u>2372</u>	<u>84</u>	<u>2468</u>	<u>88</u>	<u>2560</u>	<u>41</u>
<u>2373</u>	<u>67</u>	<u>2470</u>	<u>89</u>	<u>2562</u>	<u>76</u>
<u>2374</u>	<u>90</u>	<u>2471</u>	<u>57</u>	²⁵⁶³	<u>14</u>
<u>2375</u>	<u>66</u>	<u>2472</u>	<u>54</u>	<u>2564</u>	<u>67</u>
<u>2376</u>	<u>84</u>	<u>2473</u>	<u>63</u>	<u>2565</u>	<u>90</u>
<u>2377</u>	<u>66</u>	<u>2474</u>	<u>49</u>	<u>2567</u>	<u>77</u>
<u>2378</u>	<u>89</u>	<u>2475</u>	<u>10</u>	<u>2569</u>	<u>63</u>
<u>2379</u>	<u>84</u>	<u>2477</u>	<u>14</u>	<u>2579</u>	<u>10</u>
<u>2380</u>	<u>41</u>	<u>2478</u>	<u>17</u>	<u>2580</u>	<u>7</u>
<u>2381</u>	<u>63</u>	<u>2480</u>	<u>3</u>	<u>2581</u>	<u>11</u>
<u>2382</u>	<u>54</u>	<u>2481</u>	<u>3</u>	<u>2582</u>	<u>24</u>
<u>2383</u>	<u>41</u>	<u>2482</u>	<u>80</u>	<u>2583</u>	<u>44</u>
<u>2384</u>	<u>75</u>	<u>2483</u>	<u>10</u>	<u>2584</u>	<u>50</u>
<u>2385</u>	<u>77</u>	<u>2484</u>	<u>14</u>	<u>2586</u>	<u>23</u>
<u>2386</u>	<u>90</u>	<u>2485</u>	<u>41</u>	<u>2587</u>	<u>23</u>
<u>2387</u>	<u>90</u>	<u>2486</u>	<u>10</u>	<u>2588</u>	<u>31</u>
<u>2388</u>	<u>85</u>	<u>2487</u>	<u>69</u>	<u>2589</u>	<u>11</u>
<u>2389</u>	<u>86</u>	<u>2489</u>	<u>89</u>	<u>2590</u>	<u>80</u>
<u>2390</u>	<u>88</u>	<u>2490</u>	<u>24</u>	<u>2591</u>	<u>79</u>
<u>2392</u>	<u>14</u>	<u>2491</u>	<u>79</u>	<u>2596</u>	<u>80</u>
<u>2395</u>	<u>14</u>	<u>2492</u>	<u>43</u>	<u>2598</u>	<u>41</u>
<u>2396</u>	<u>43</u>	<u>2493</u>	<u>18</u>	<u>2599</u>	<u>63</u>
<u>2397</u>	<u>90</u>	<u>2494</u>	<u>24</u>	<u>2600</u>	<u>54</u>
<u>2398</u>	<u>85</u>	<u>2495</u>	<u>10</u>	<u>2601</u>	<u>50</u>
<u>2400</u>	<u>70</u>	<u>2498</u>	<u>43</u>	<u>2602</u>	<u>17</u>
<u>2401</u>	<u>75</u>	<u>2499</u>	<u>31</u>	<u>2603</u>	<u>31</u>
<u>2402</u>	<u>4</u>	<u>2500</u>	<u>88</u>	<u>2607</u>	<u>69</u>
<u>2403</u>	<u>14</u>	<u>2502</u>	<u>28</u>	<u>2608</u>	<u>76</u>
<u>2404</u>	<u>41</u>	<u>2503</u>	<u>54</u>	<u>2609</u>	<u>41</u>
<u>2405</u>	<u>41</u>	<u>2504</u>	<u>16</u>		
<u>2406</u>	<u>15</u>	<u>2505</u>	<u>41</u>		
<u>2407</u>	<u>23</u>	<u>2507</u>	<u>67</u>		
<u>2409</u>	<u>41</u>	<u>2508</u>	<u>43</u>		
<u>2411</u>	<u>63</u>	<u>2509</u>	<u>41</u>		
<u>2412</u>	<u>3</u>	<u>2510</u>	<u>63</u>		
<u>2414</u>	<u>86</u>	<u>2512</u>	<u>44</u>		
<u>2415</u>	<u>82</u>	<u>2514</u>	<u>81</u>		

